

ENGLISH



Canon

PowerShot SD700 IS
DIGITAL ELPH

DIGITAL
IXUS 800 IS



Before Using the Camera

Shooting

Playback/Erasing

Print/Transfer Settings

Viewing Images on a TV set

Customizing the Camera

Troubleshooting

List of Messages

Appendix

Advanced

Camera User Guide

This guide explains camera features and procedures in detail.

DiGiC II



Canon DIGITAL CAMERA

PowerShot SD700 IS
DIGITAL ELPH

DIGITAL
IXUS 800 IS Advanced Camera User Guide

Canon

Main Features



Shooting

- Automatically adjusts shooting settings to match particular conditions (Special Scene mode)
- Automatically detects camera orientation with an Intelligent Orientation sensor
- Reduces image blur with the IS Mode
- Avoid the effects of camera shake or blurry subjects when shooting by using high ISO speed
- Changes image colors to create special effects (Color Accent, Color Swap)

Playback

- Plays movies with sound
- Auto plays slideshows

Editing

- Adds effects to still images with the My Colors function
- Records sound memos for still images
- Edits movies

Printing

- Makes printing easy with the Print/Share button
- Also supports non-Canon brand *PictBridge* compliant printers

Uses of Recorded Images

- Effortlessly transfer them to a computer with the Print/Share button
- Freely customize the start-up image or start-up sound using the My Camera settings

Conventions Used in this Guide

Icons appearing below titles indicate the modes in which the procedure can be used.



See *Functions Available in Each Shooting Mode* (p. 136).

In this guide, the *Basic Camera User Guide* is referred to as the *Basic Guide*, and the *Advanced Camera User Guide* is referred to as the *Advanced Guide*.



This mark denotes issues that may affect the camera's operation.



This mark denotes additional topics that complement the basic operating procedures.

You can use SD* memory cards and MultiMediaCards with this camera. These cards are collectively called memory cards in this guide.

* SD stands for Secure Digital, a copyright protection system.

Use of genuine Canon accessories is recommended.

This product is designed to achieve excellent performance when used with genuine Canon accessories. Canon shall not be liable for any damage to this product and/or accidents such as fire, etc., caused by the malfunction of non-genuine Canon accessories (e.g., a leakage and/or explosion of a battery pack). Please note that this warranty does not apply to repairs arising out of the malfunction of non-genuine Canon accessories, although you may request such repairs on a chargeable basis.

Table of Contents

Items marked with a ☆ are lists or charts that summarize camera functions or procedures.

Conventions Used in this Guide	1
Handling Precautions	5
Please Read	5
Safety Precautions	6
Preventing Malfunctions	11
Before Using the Camera—The Components Guide	12
Before Using the Camera—Basic Operations	15
Using the LCD Monitor	15
LCD Monitor Brightness	17
Information Displayed on the LCD Monitor	18
Using the Viewfinder	21
Indicators	22
Power Saving Function	22
Setting the World Clock	23
Menus and Settings	25
Menu List	27
Resetting Settings to Their Default Values	31
Formatting Memory Cards	32
Shooting	33
Changing the Recording Pixels and Compression (Still Images)	33
How to Use the IS Mode	35
SCN Shooting in a Special Scene Mode	36
Ⓜ Shooting in Manual Mode	36
Magnified Close-Up Shooting (Digital Macro)	37
Using the Digital Zoom	38
📄 Continuous Shooting	39
Postcard Date Imprint Mode	40
🕒 Using the Self-Timer	41
🎬 Movie Shooting	43
Shooting Panoramic Images (Stitch Assist)	47



Switching between Focusing Modes	49
Shooting Hard-to-Focus Subjects (Focus Lock, AF Lock)	50
Locking the Exposure Setting (AE Lock)	51
Locking the Flash Exposure Setting (FE Lock)	52
Switching between Metering Modes	53
Adjusting the Exposure Compensation	54
Shooting in Long Shutter Mode	55
Adjusting the Tone (White Balance)	57
Shooting in a My Colors Mode	60
Changing Colors	62
ISO Adjusting the ISO Speed	67
Setting the Auto Rotate Function	68
Creating an Image Destination (Folder)	69
Resetting the File Number	70
Playback/Erasing	73
Q Magnifying Images	73
🔲 Viewing Images in Sets of Nine (Index Playback)	74
🏠 Jumping to Images	75
Viewing Movies	76
Editing Movies	77
Rotating Images in the Display	79
Playback with Transition Effects	80
Adding Effects with the My Colors Function	81
Attaching Sound Memos to Images	82
Automated Playback (Slide Shows)	84
Protecting Images	88
Erasing All Images	88
Print Settings/Transfer Settings	89
Setting the DPOF Print Settings	89
Setting the DPOF Transfer Settings	92

Viewing Images on a TV set	94
Customizing the Camera (My Camera Settings)	95
Changing My Camera Settings	95
Registering My Camera Settings	96
Troubleshooting	98
Camera	98
When the power is turned on	98
LCD monitor	99
Shooting	100
Shooting Movies	104
Playback	105
Battery/Battery Charger	106
TV monitor output	106
Printing on Direct Print Compatible Printers	107
List of Messages	108
Appendix	111
Battery Handling	111
Handling the Memory Card	113
Using an AC Adapter Kit (Sold Separately)	115
Using an Externally Mounted Flash (Sold Separately)	116
Camera Care and Maintenance	118
Specifications	119
INDEX	127
☆ Functions Available in Each Shooting Mode	136

Handling Precautions

Please Read

Test Shots

Before you try to photograph important subjects, we highly recommend that you shoot several trial images to confirm that the camera is operating and being operated correctly.

Please note that Canon Inc., its subsidiaries and affiliates, and its distributors are not liable for any consequential damages arising from any malfunction of a camera or accessory, including memory cards, that results in the failure of an image to be recorded or to be recorded in a way that is machine readable.

Warning Against Copyright Infringement

Please note that Canon digital cameras are intended for personal use and should never be used in a manner that infringes upon or contravenes international or domestic copyright laws and regulations. Please be advised that in certain cases the copying of images from performances, exhibitions, or commercial properties by means of a camera or other device may contravene copyright or other legal rights even if the image was shot for personal use.

Warranty Limitations

This camera's warranty is only effective in the country of sale. If a problem arises while the camera is in use abroad, please convey it back to the country of sale before proceeding with a warranty claim to a Canon Customer Support Help Desk.

For Canon Customer Support contacts, please see the customer support list supplied with your camera.

Camera Body Temperature

If your camera is used for prolonged periods, the camera body may become warm. Please be aware of this and take care when operating the camera for an extended period.

About the LCD Monitor

The LCD monitor is produced with extremely high-precision manufacturing techniques. More than 99.99% of the pixels operate to specification. Less than 0.01% of the pixels may occasionally misfire or appear as red or black dots. This has no effect on the recorded image and does not constitute a malfunction.

Video Format

Please set the camera's video signal format to the one used in your region before using it with a TV monitor (p. 94).

Language Setting

Please see the *Basic Guide* (p. 4) to change the language setting.

Safety Precautions

- Before using the camera, please ensure that you read the safety precautions described below and in the "Safety Precautions" section of the *Basic Camera User Guide*. Always ensure that the camera is operated correctly.
- The safety precautions noted on the following pages are intended to instruct you in the safe and correct operation of the camera and its accessories to prevent injuries or damage to yourself, other persons and equipment. Be sure you fully understand them before reading the rest of the manual.
- Equipment refers to the camera, battery charger or separately sold compact power adapter.
- Battery refers to the battery pack.

Warnings

Equipment

- **Do not look directly at the sun or at other intense light sources through the viewfinder that could damage your eyesight.**

- **Store this equipment out of the reach of children and infants.**
 - Wrist strap: Placement of the strap around the child's neck could result in asphyxiation.
 - Memory card: Dangerous if accidentally swallowed. If this occurs, contact a doctor immediately.

- **Do not attempt to disassemble or alter any part of the equipment that is not expressly described in this guide.**
- **To avoid the risk of high-voltage electrical shock, do not touch the flash portion of the camera if it has been damaged.**
- **Stop operating the equipment immediately if it emits smoke or noxious fumes.**
- **Do not allow the equipment to come into contact with, or become immersed in, water or other liquids. If the exterior comes into contact with liquids or salt air, wipe it dry with a soft, absorbent cloth.**

Continued use of the equipment may result in fire or electrical shock. Immediately turn the camera power off and remove the camera battery or unplug the power cord from the power outlet. Please consult your camera distributor or the closest Canon Customer Support Help Desk.

- **Do not use substances containing alcohol, benzene, thinners or other flammable substances to clean or maintain the equipment.**
- **Do not cut, damage, alter or place heavy items on the power cord.**
- **Use only recommended power accessories.**
- **Remove the power cord on a regular periodic basis and wipe away the dust and dirt that collects on the plug, the exterior of the power outlet and the surrounding area.**
- **Do not handle the power cord if your hands are wet.**

Continued use of the equipment may result in fire or electrical shock.

Battery

- **Do not place the battery near a heat source or expose it to direct flame or heat.**
- **The battery should not be immersed in water or sea water.**
- **Do not attempt to disassemble, alter or apply heat to the battery.**
- **Avoid dropping or subjecting the battery to severe impacts that could damage the casing.**
- **Use only recommended battery and accessories.**

Use of battery not expressly recommended for this equipment may cause explosions or leaks, resulting in fire, injury and damage to the surroundings. In the event that a battery leaks and the eyes, mouth, skin or clothing contact these substances, immediately flush with water and seek medical assistance.

- **Disconnect the battery charger and compact power adapter from both the camera and the power outlet after recharging or when they are not in use to avoid fire and other hazards.**
- **Do not place anything, such as tablecloths, carpets, bedding or cushions, on top of the battery charger while it is charging.**

Continued use over a long period may cause the units to overheat and distort, resulting in fire.

- **Use only the specified battery charger to charge the battery.**
- **The battery charger and compact power adapter are designed for exclusive use with your camera. Do not use it with other products or batteries.**

There is a risk of overheating and distortion which could result in fire or electrical shock.

- **Before you discard a battery, cover the terminals with tape or other insulators to prevent direct contact with other objects.**

Contact with the metallic components of other materials in waste containers may lead to fire or explosions.

Others

- **Do not trigger the flash in close proximity to human or animal eyes. Exposure to the intense light produced by the flash may damage eyesight.**

In particular, remain at least one meter (39 inches) away from infants when using the flash.

- **Keep objects that are sensitive to magnetic fields (such as credit cards) away from the speaker of the camera.**

Such items may lose data or stop working.

Cautions

Equipment

- **Be careful not to bang the camera or subject it to strong impacts or shocks that could lead to injury or damage the equipment when wearing or holding it by the strap.**

- **Do not store the equipment in humid or dusty areas.**

- **Do not allow metal objects (such as pins or keys) or dirt to contact the charger terminals or plug.**

Such conditions could lead to fire, electrical shock or other damage.

- **Avoid using, placing or storing the equipment in places subject to strong sunlight or high temperatures, such as the dashboard or trunk (boot) of a car.**

- **Do not use the equipment in a manner that exceeds the rated capacity of the electrical outlet or wiring accessories. Do not use if the power cord or plug are damaged, or if not fully plugged into the outlet.**

- **Do not use in locations with poor ventilation.**

The above-mentioned can cause leakage, overheating or explosion, resulting in fire, burns or other injuries. High temperatures may also cause deformation of the casing.

- **When not using the camera for extended periods of time, remove the battery from the camera or battery charger and store the equipment in a safe place.**

The battery can run down.

Equipment

- **Do not connect compact power adapters or battery chargers to devices such as electrical transformers for foreign travel because it may lead to malfunctions, excessive heat generation, fire, electric shock or injury.**

Flash

- **Do not operate the flash with dirt, dust or other items stuck to the surface of the flash.**
- **Be careful not to cover the flash with your fingers or clothing when shooting.**

The flash may be damaged and emit smoke or noise. The resulting heat build-up could damage the flash.

- **Do not touch the surface of the flash after taking several pictures in rapid succession.**

Doing so could result in burns.

Preventing Malfunctions

Avoid Strong Magnetic Fields

- **Never place the camera in close proximity to electric motors or other equipment generating strong electromagnetic fields.**

Exposure to strong magnetic fields may cause malfunctions or corrupt image data.

Avoid Condensation Related Problems

- **When moving the equipment rapidly between hot and cold temperatures, you can avoid condensation by placing the equipment in an airtight, resealable plastic bag and letting it adjust to temperature changes slowly before removing it from the bag.**

Moving the equipment rapidly between hot and cold temperatures may cause condensation (water droplets) to form on its external and internal surfaces.

If Condensation Forms Inside the Camera

- **Stop using the camera immediately.**

Continued use may damage the equipment. Remove the memory card and battery or compact power adapter from the camera and wait until the moisture evaporates completely before resuming use.

Before Using the Camera—The Components Guide

Front View

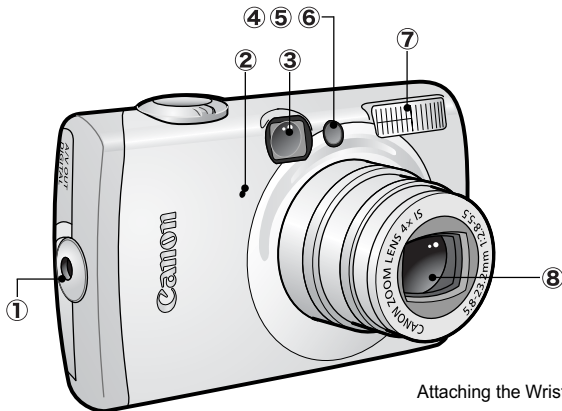

Attaching the Wrist Strap*

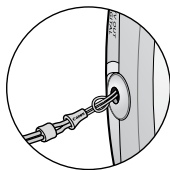

- ① Wrist Strap Mount
- ② Microphone (p. 82)
- ③ Viewfinder Window (p. 21)
- ④ AF-assist Beam (p. 27)
- ⑤ Red-Eye Reduction Lamp (*Basic Guide* p. 9)
- ⑥ Self-Timer Lamp (p. 41)
- ⑦ Flash (*Basic Guide* p. 9)
- ⑧ Lens

* When carrying the camera by the strap, be careful not to swing the camera or catch it on other items.

Back View

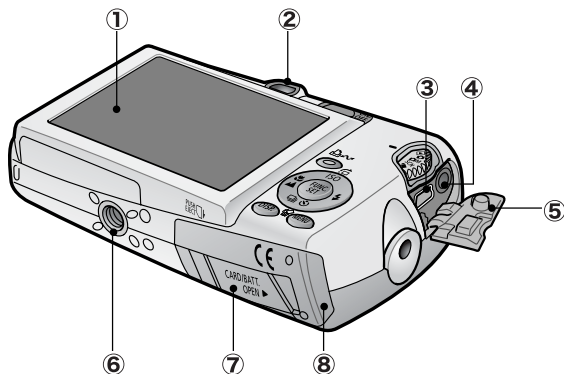

- ① LCD Monitor (p. 15)
- ② Viewfinder (p. 21)
- ③ DIGITAL Terminal (*Basic Guide* p. 19)
- ④ AV OUT (Audio/Video output) Terminal (p. 94)
- ⑤ Terminal Cover (*Basic Guide* p. 19)
- ⑥ Tripod Socket
- ⑦ DC Coupler Terminal Cover (p. 115)
- ⑧ Memory Card Slot/Battery Cover (*Basic Guide* p. 2)



The interface cable and AV cable cannot be connected simultaneously.

Operation Panel

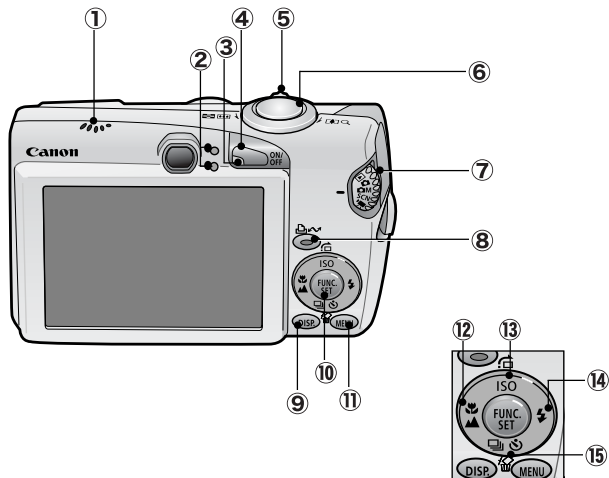

- ① Speaker
- ② Indicators (p. 22)
- ③ Power Lamp
- ④ Power Button (*Basic Guide* p. 5)
- ⑤ Zoom Lever (p. 73, *Basic Guide* p. 9)
Shooting: (Wide Angle)/ (Telephoto)
Playback: (Index)/ (Magnify)
- ⑥ Shutter Button (*Basic Guide* p. 5)
- ⑦ Mode Dial (*Basic Guide* pp. 5, 6)
- ⑧ (Print/Share) Button (*Basic Guide* pp. 14, 22)
- ⑨ **DISP.** (Display) Button (p. 15)
- ⑩ **FUNC./SET** (Function/Set) Button (p. 25)
- ⑪ **MENU** Button (p. 26)
- ⑫ (Macro)/ (Infinity)/ Button (*Basic Guide* p. 10)
- ⑬ **ISO** (ISO Speed)/ (Jump)/ Button (pp. 67, 75)
- ⑭ (Flash)/ Button (*Basic Guide* p. 9)
- ⑮ (Single Image Erase)/ (Continuous)/ (Self-timer)/ Button (pp. 39, 41, *Basic Guide* p. 11)

Using the LCD Monitor

1 Press .

- The display mode changes as follows with each press.

Shooting Mode (, , or)

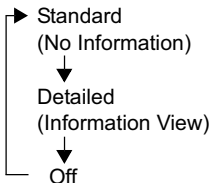



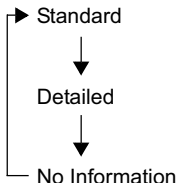

Playback Mode ()



- In the shooting modes, the shooting information displays for approximately 6 sec. when a setting is changed, regardless of the selected display mode.



- The LCD monitor on or off setting is retained even after the camera power is turned off.
- The LCD monitor does not shut off in the , , ,  or  mode.
- The LCD monitor will not switch to the detailed display in the index playback mode (p. 74).

Using the Clock

You can display the current date and time for a 5-second* interval using the following two methods.

* Default setting



Method 1

Hold the **FUNC./SET** button down while turning on the power.

Method 2

In a shooting mode, hold the **FUNC./SET** button down.

If you hold the camera horizontally, it displays the time. If you hold it vertically, the time and date display.

However, if you hold the camera vertically and use method 1 to display the date and time, the time will be initially displayed in the same way as when the camera is held horizontally.

- You can change the display color by pressing the ◀ or ▶ button.
- The clock display will cease when the display interval is over or when you operate the **FUNC./SET**, **MENU** or shutter button or the mode dial.
- The clock's display interval can be changed in the **11** (Set up) menu (p. 29).

LCD Monitor Brightness

LCD Monitor Brightness Settings

The brightness of the LCD monitor can be changed in the following two ways.

- Changing Settings Using the Set up Menu (p. 29)
- Changing Settings Using the **DISP.** Button (Quick-bright LCD Function)

You can set the LCD monitor to the brightest setting regardless of the option selected in the Set up menu by pressing the **DISP** button for more than one second.*

- To restore the previous brightness setting, press the **DISP** button for more than one second again.
- The next time you turn on the camera, the LCD monitor will be at the brightness setting selected in the Set up menu.

* You cannot change the brightness of the LCD monitor with this function if you have already set it to its highest setting in the Set up menu.

Night Display

When shooting in dark conditions, the camera automatically brightens the LCD monitor to suit the brightness of the subject*, making it easier to frame the subject.

* The movement of the subject shown on the LCD monitor will be jerky, but it will not affect the recorded images. The brightness of the image displayed in the monitor, and the brightness of the actual image recorded will be different.

Information Displayed on the LCD Monitor

Shooting Information (Shooting mode)

[] * Spot Frame

* AF Frame (p. 49)

* Low Battery (p. 111)

* Zoom Magnification* (p. 38)

* Grid Lines* (p. 27)

* IS Mode (p. 35)

- Stills: Recordable Shots
- Movies: Remaining Time/Elapsed Time

ISO 80 ISO 100 ISO 200 ISO 400 ISO 800 HI
ISO Speed (p. 67)

Shooting Method (pp. 39, 41)

Macro/Infinity (*Basic Guide* p. 10)

Flash (*Basic Guide* p. 9)

Auto Rotate (p. 68)

● Rec. *
Movie Recording (p. 43)

* AE Lock (p. 51)

* FE Lock (p. 52)

* AF Lock (p. 50)

Time Zone (p. 23)

* Create Folder (p. 69)

Metering Mode (p. 53)

Compression (Still Images) (p. 33)

Frame Rate (Movie) (p. 46)

Recording Pixels (pp. 33, 46)

(Red)* Camera Shake Warning (p. 99)
(The shutter speed will also display when the displays.)

* Exposure Shift Bar (Movie) (p. 45)

Shooting Mode (pp. 36, 43, 47, 63, 64, *Basic Guide* pp. 6 – 8)



-2 ... +2
Exposure Compensation (p. 54)

1" ... 15"
Long Shutter Mode (p. 55)

White Balance (p. 57)

My Colors (p. 60)



- If the indicator blinks orange and the camera shake icon  displays, it indicates there is insufficient illumination and a slow shutter speed will be selected. Shoot using the following methods.
 - Set IS mode to a setting other than [Off] (p. 35).
 - Raise the ISO speed (p. 67).
 - Select a setting other than  (flash off).
 - Attach the camera to a tripod or other device.

Playback Information (Playback Mode)

Standard

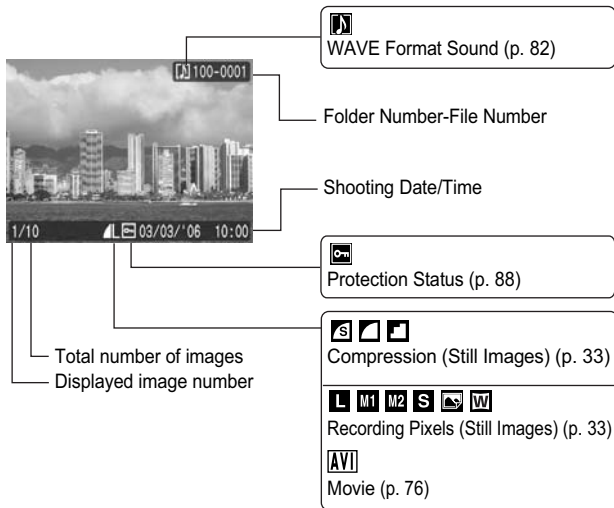

Detailed



Histogram

<p>Shooting Mode (pp. 36, 43, 47, 63, 64, <i>Basic Guide</i> pp. 6 – 8)</p>	<p>Exposure Compensation (p. 54)</p>
<p>Image with the My Colors effect (p. 81)</p>	<p>Flash (<i>Basic Guide</i> p. 9)</p>
<p>Long Shutter Mode (p. 55)</p>	<p>Macro/Infinity (<i>Basic Guide</i> p. 10)</p>
<p>ISO Speed (p. 67)</p>	<p>My Colors (Shooting) (p. 60)</p>
<p>Recording Pixels (Movies) (p. 46)</p>	<p>My Colors (Playback) (p. 81)</p>
<p>Frame Rate (Movies) (p. 46)</p>	<p>Metering Mode (p. 53)</p>
	<p>White Balance (p. 57)</p>
	<p>File Size</p>
	<p>Recording Pixels (Still Images) (p. 33)</p>
	<p>Movie Length (Movies) (p. 43)</p>

The following information may also be displayed with some images.

	A sound file in a format other than the WAVE format is attached or the file format is not recognized.
	JPEG image not conforming to Design rule for Camera File System Standards
	RAW image
	Unrecognized data type



Information for images shot on other cameras may not display correctly.

Histogram Function

The histogram is a graph that allows you to judge the brightness of the image. The greater the bias toward the left in the graph, the darker the image. The greater the bias toward the right, the brighter the image.

If the image is too dark, adjust the exposure compensation to a positive value. Similarly, adjust the exposure compensation to a negative value if the image is too bright (p. 54).

Sample Histograms



Dark Image



Balanced Image



Bright Image

Using the Viewfinder

The viewfinder can be used to conserve power by turning the LCD monitor off (p. 15) while shooting.

Indicators

The camera indicators light or flash under the following circumstances.



Never do the following while a green indicator is flashing. These actions may corrupt image data.

- Shake or jolt the camera
- Shut off the power, or open the memory card slot/battery cover

●Upper Indicator

- Green: Ready to shoot
Blinking Green: Image recording/reading/erasing/transferring (when connected to a computer)
Orange: Ready to shoot (flash on)
Blinking Orange: Ready to shoot (camera shake warning)

●Lower Indicator

- Yellow: Macro mode/infinity mode/AF lock mode
Blinking Yellow: Focusing difficulty (camera beeps once)

Power Saving Function

This camera is equipped with a power saving function. The power will shut off in the following circumstances. Press the power button again to restore power.

Shooting Mode	Powers down approximately 3 minutes after the last control is accessed on the camera. The LCD monitor automatically turns off 1 minute* after the last control is accessed even if [Auto Power Down] is set to [Off]. Press any button other than the power button or change the camera orientation to turn the LCD monitor back on.
Playback Mode Connected to a Printer	Powers down approximately 5 minutes after the last control is accessed on the camera.

* This time can be changed.



- The power saving function will not activate during a slide show or while the camera is connected to a computer.
- The power saving function settings can be changed (p. 29).

Setting the World Clock

When traveling abroad, you can record images with local dates and times simply by switching the time zone setting if you pre-register the destination time zones. You can enjoy the convenience of not having to switch the Date/Time settings.

Setting the Home/World Time Zones

- 1 **[F1] (Set up) Menu ▶ [Time Zone] ▶ **

See *Menus and Settings* (p. 26).



- 2 ** ▶ **



- 3 **Use the \leftarrow or \rightarrow button to select a home time zone**



- To set the daylight saving option, use the \uparrow or \downarrow button to display . The time will advance by 1 hour.

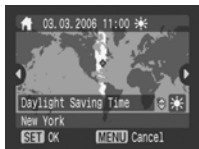

- 4 ** ▶ **



5 Use the ← or → button to select a destination time zone .

- As in Step 3, you can set the day-light saving option.

Time Difference from the Home Time Zone



6 Use the ↑ or ↓ button to select [Home/World], and the ← or → button to select .

Switching to the Destination Time Zone

1 (Set up) Menu [Time Zone] .

See Menus and Settings (p. 26).



2 Use the ← or → button to select .

- To change the destination time zone, use the **FUNC./SET** button.

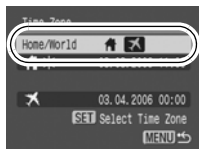

If you change the date and time when the World option is selected, the Home date and time will also change automatically.

Menus and Settings

Menus are used to set the shooting, playback and print settings as well as such camera settings as the date/time and electronic beep. The following menus are available.

●FUNC. Menu

●Rec., Play, Print, Set up and My Camera Menus

FUNC. Menu

This menu sets many of the common shooting functions.

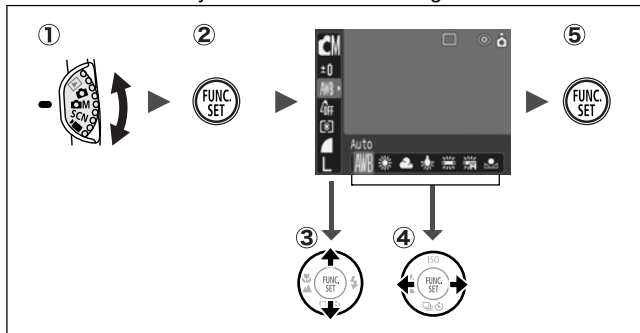

- ① Turn the mode dial to **CAM**, **SCN** or **P**.
- ② Press the **FUNC./SET** button.
- ③ Use the **↑** or **↓** button to select a menu item.
Some items may not be selectable in some shooting modes.
- ④ Use the **←** or **→** button to select an option for the menu item.
You can select further options with the **MENU** button for some options.
After selecting an option, you can press the shutter button to shoot immediately. After shooting, this menu will appear again, allowing you to adjust the settings easily.
- ⑤ Press the **FUNC./SET** button.

Rec., Play, Print, Set up and My Camera Menus

Convenient settings for shooting, playback or printing can be set with these menus.

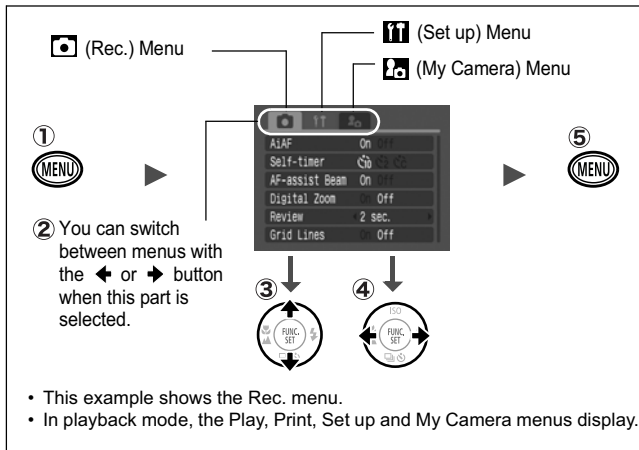

① **Press the MENU button.**

② **Use the ◀ or ▶ button to switch between menus.**

You can also use the zoom lever to switch between menus.

③ **Use the ▲ or ▼ button to select menu items.**

Some items may not be selectable in some shooting modes.

④ **Use the ◀ or ▶ button to select an option.**

Menu items followed by an ellipsis (...) can only be set after pressing the **FUNC./SET** button to display the next menu.













Press the **FUNC./SET** button again to confirm the setting.

⑤ **Press the MENU button.**

Menu List



FUNC. Menu

The icons shown below are the default settings.

Menu Item	Page	Menu Item	Page
 Manual Mode	p. 36	 My Colors	p. 60
 Special Scene Mode	p. 36	 Metering Mode	p. 53
 Movie Mode	p. 43	 Compression (Still Image)	p. 33
 Exposure Compensation	p. 54	 Frame Rate (Movie)	p. 46
 Long Shutter Mode	p. 55	 Recording Pixels (Still Image)	p. 33
 White Balance	p. 57	 Recording Pixels (Movie)	p. 46









Rec. Menu

* Default setting

Menu Item	Options	Page/Topic
AiAF	On*/Off	p. 49
Self-timer	 10 seconds*/  2 seconds/  Custom Timer (Delay: 0–10*, 15, 20, 30 sec.) (Shots: 1–3*–10)	p. 41
AF-assist Beam	On*/Off	–
Digital Zoom	On/Off* (On in standard movie mode.)	p. 38
Review	Off/2*–10 seconds/Hold	<i>Basic Guide</i> p. 6
Save Original	On/Off*	p. 66
Grid Lines	On/Off*	You can display grid lines (splits screen into nine areas) to make it easier to judge the horizontal and vertical alignment of a photographic subject and to make composition easier. The lines will not be recorded in the images.

IS Mode	Off/Continuous*/Shoot Only/ Panning	p. 35
Date Stamp	Off*/Date/Date & Time	p. 40
Long Shutter	On/Off*	p. 55

Play Menu

Menu Item	Page	Menu Item	Page
 Transition	p. 80	 Protect	p. 88
 Slide Show	p. 84	 Rotate	p. 79
 My Colors	p. 81	 Erase All	p. 88
 Sound Memo	p. 82	 Transfer Order	p. 92

Print Menu

Menu Item	Page	Menu Item	Page
Print	p. 89	Clear All Selections	p. 91
Select Images & Qty.		Print Settings	
Select All Images			



Set up Menu

* Default setting

Menu Item	Options	Page/Topic
Mute	On/Off*	Set to [On] to silence all sounds except warning sounds. (<i>Basic</i> p. 5)
Volume	Off/1/2*/3/4/5	Adjusts the volume of the start-up sound, operation sound, self-timer sound, shutter sound and playback sound. The volume cannot be adjusted if [Mute] is set to [On].
Start-up Vol.		Adjusts the volume of the start-up sound when the camera is turned on.
Operation Vol.		Adjusts the volume of the operation sound that plays when any button other than the shutter button is pressed.
Selftimer Vol.		Adjusts the volume of the self-timer sound played 2 sec. before the shutter is released.





Shutter Volume		Adjusts the volume of the sound played when the shutter releases. The shutter sound does not play when a movie is recording.
Playback Vol.		Adjusts the volume of movie sounds and sound memos.
LCD Brightness	-7 to 0* to +7	Use the ◀ or ▶ button to adjust the brightness. If you press the ▲ or ▼ button, the display returns to the Set up menu. You can check the brightness in the LCD monitor while you are adjusting the setting.
Power Saving		p. 22
Auto Power Down	On*/Off	Sets whether or not the camera automatically powers down after a set period of time elapses without the camera being operated.
Display Off	10 sec./20 sec./ 30 sec./1 min.*/ 2 min./3min.	Sets the length of time before the LCD monitor turns off when no camera operation is performed.
Time Zone	Home*/World	p. 23
Date/Time		<i>Basic Guide</i> p. 4
Clock Display	0–5*–10 sec./20 sec./30 sec./1 min./2 min./3 min.	p. 16
Format		p. 32
File Numbering	Continuous*/ Auto Reset	p. 70
Create Folder		p. 69
Create New Folder	Check mark (On)/ No check mark (Off)	Creates a folder for the next shooting session.
Auto Create	Off*/Daily/ Monday–Sunday/ Monthly	You can also set a creation time.
Auto Rotate	On*/Off	p. 68

Lens Retract	1 min.* / 0 sec.	Sets the timing of the lens retraction when you switch from the shooting to the playback mode.
Language		<i>Basic Guide p. 4</i>
Video System	NTSC/PAL	p. 94
Print Method	Auto* / 	See below. *1
Reset All		p. 31

*1 You can change the printer connection method. There is usually no need to change the settings, but select  when you print an image recorded in the  (Widescreen) mode at the full page setting for wide paper using a Canon SELPHY CP710/CP510 Compact Photo Printer. Since this setting is saved even when the power is turned off, ensure that you return the setting to [Auto] to print other image sizes.

My Camera Menu

* Default setting

Menu Item	Available Settings	Page
Theme	Selects a common theme for each My Camera settings item.	p. 95
Start-up Image	Sets the image displayed when the camera power is turned on.	
Start-up Sound	Sets the sound played when the camera power is turned on.	
Operation Sound	Sets the sound played when any button other than the shutter button is pressed.	
Selftimer Sound	Sets the sound played 2 seconds before the shutter releases in self-timer mode.	
Shutter Sound	Sets the sound played when the shutter button is pressed. There is no shutter sound for movies.	
My Camera Menu Contents	 (Off)  * /  / 	

Resetting Settings to Their Default Values

1 (Set up) Menu ► [Reset All].

See *Menus and Settings* (p. 26).

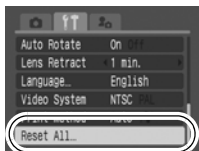

2 Select [OK] and press .



- Settings cannot be reset when the camera is connected to a computer or to a printer.
- The following cannot be reset.
 - Shooting mode
 - The [Time Zone], [Date/Time], [Language] and [Video System] options in the  (Set up) menu (p. 29, 30)
 - White balance data recorded with the custom white balance function (p. 58)
 - Colors specified in the [Color Accent] (p. 63) or [Color Swap] (p. 64) modes.
 - Newly added My Camera settings (p. 96)

Formatting Memory Cards

You should always format a new memory card or one from which you wish to erase all images and other data.



Please note that formatting (initializing) a memory card erases all data, including protected images and other file types.

1

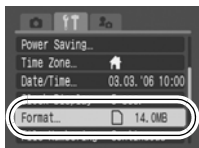

(Set up) Menu ► [Format].

See *Menus and Settings* (p. 26).



2

Select [OK] and press .

- To perform a low level format, use the  button to select [Low Level Format] and the  or  button to add a check mark.
- You can stop formatting a card when [Low Level Format] is selected by pressing the **FUNC./SET** button. You can still use a card without problem when formatting is halted, but its data will be erased.

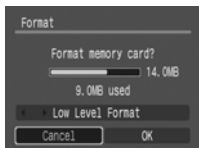

Low Level Format

We recommend you select [Low Level Format] when you think that the recording/reading speed of a memory card has dropped. A low level format may require 2 to 3 minutes with some memory cards.



Changing the Recording Pixels and Compression (Still Images)

Shooting Mode            

1 FUNC. Menu * (Recording Pixels)/ * (Compression).





See *Menus and Settings* (p. 25).

* Default setting.

- Use the  or  button to select recording pixels/compression settings and press the **FUNC./SET** button.





Approximate Values for Recording Pixels

Recording Pixels		Purpose	
L (Large)	2816 x 2112 pixels	High   Low	Printing to about A3-size* 297 x 420 mm (11.7 x 16.5 in.)
M1 (Medium 1)	2272 x 1704 pixels		Printing to about A4-size* 210 x 297 mm (8.3 x 11.7 in.) Printing to about Letter-size* 216 x 279 mm (8.5 x 11 in.)
M2 (Medium 2)	1600 x 1200 pixels		Print postcard-size prints 148 x 100 mm (6 x 4 in.) Print L-size prints 119 x 89 mm (4.7 x 3.5 in.)
S (Small)	640 x 480 pixels		Send images as e-mail attachments or shoot more images
  (Postcard Date Imprint Mode)	1600 x 1200 pixels		When printing to postcards (p. 40).
W Widescreen	2816 x 1584 pixels	Print on wide paper (Records at a 16:9 width-to-height aspect ratio. Portions not recorded are left black.)	

* Paper sizes vary according to region.

Approximate Values for Compression Settings

Compression		Purpose
 Superfine	High Quality	Shoot higher quality images
 Fine	↕	Shoot normal quality images
 Normal	Normal	Shoot more images



- See *Image Data Sizes (Estimated)* (p. 124).
- See *Memory Cards and Estimated Capacities* (p. 123).

How to Use the IS Mode



Shooting Mode



By using the IS mode, you can reduce image blur when magnifying a distant subject or shooting in low-light situations.

	Continuous	You can check the effect of the IS mode on image blur on the LCD monitor since the IS mode runs continually. This makes it easier to compose images and focus on subjects.
	Shoot Only	IS mode is only activated when the shutter button is pressed, so subjects will be captured with reduced blur even if their movements the LCD monitor are not smooth. This option is not available in the mode.
	Panning	This option only stabilizes the effect of up and down camera motions on the image. This option is recommended for shooting objects moving horizontally. This option is not available in the mode.

1

(Rec.) Menu **[IS Mode]** **[Off]/[Continuous]*/[Shoot Only]/[Panning].**

See *Menus and Settings* (p. 26).

*Default setting.

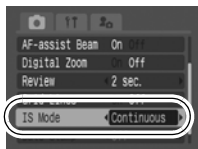

- It may not be possible to completely stabilize images when shooting at night or at low shutter speeds. Use a tripod to shoot under these conditions.
- Excessive hand motion may not be completely stabilized.
- Use the camera in its horizontal orientation for panning (the IS mode has no effect in the vertical orientation).

SCN Shooting in a Special Scene Mode

SCN

Shooting Mode



You can take an optimal picture simply by selecting the appropriate shooting mode.

1 FUNC. Menu ► * (Portrait).

See *Menus and Settings* (p. 25).

*Default setting.

- Use the ◀ or ▶ button to select a shooting mode and press the **FUNC./SET** button.
- See the *Basic Guide* (p. 7) for explanations of the Special Scene modes.

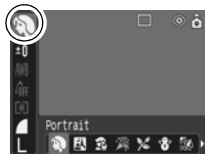

2 Shoot.

Shooting in Manual Mode

CM

Shooting Mode



You can adjust settings yourself, such as the exposure, white balance and ISO speed, when shooting in this mode.

1 FUNC. Menu ► * (Manual).

See *Menus and Settings* (p. 25).

*Default setting.

- See the *Basic Guide* (p. 7) for Manual mode explanations.



2 Change the settings as required and shoot.

Magnified Close-Up Shooting (Digital Macro)

Shooting Mode 

You can shoot a subject 2 – 60 cm (0.79 in. – 2.0 ft.) from the end of the lens at the maximum wide angle setting. With the digital zoom, the image area is 7.5 x 5.5 mm (0.30 x 0.22 in.) at maximum zoom (approximately 4.0 times).

1 FUNC. Menu * (Manual) (Digital Macro).

See *Menus and Settings* (p. 25).

*Default setting.



2 Choose the angle of view with the zoom lever and shoot.

Using the Digital Zoom



Shooting Mode



You can shoot zoomed images using the combined digital and optical zooms.

- Stills: zoom up to approximately 16 times
- Movies (Standard): zoom up to approximately 16 times



- The digital zoom cannot be used when the LCD monitor is turned off.
- The digital zoom cannot be used in the (Postcard Date Imprint mode) or the (Widescreen) mode.

1

(Rec.) Menu ► [Digital Zoom] ► [On].

See *Menus and Settings* (p. 26).

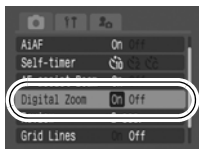

2

Press the zoom lever toward and shoot.

- The combined digital and optical zoom setting will display in the LCD monitor.
- When you press the zoom lever toward , the zoom stops when the lens reaches the maximum optical telephoto setting (when shooting still images).
Press the zoom lever toward again to activate the digital zoom and further zoom the image digitally.
- Press the zoom lever toward to zoom out.



Images become coarser the more they are digitally zoomed.



In this mode, the camera shoots continuously while the shutter button is held down.

If you use the recommended memory card*, you can shoot continuously (smooth continuous shooting) at a set shooting interval until the memory card is full (p. 123).

*Recommended Memory Card

Super high speed SDC-512 MSH memory card (sold separately) newly formatted with low level formatting (p. 32).



- This reflects standard shooting criteria established by Canon. Actual results may vary according to the subject and shooting conditions.
- Even if continuous shooting suddenly stops, the memory card may not be full.

1 Press the  to display .

2 Shoot.

- The camera will continue to record successive images while the shutter button is fully pressed. Recording will cease when the shutter button is released.

To Cancel Continuous Shooting

Press the  button twice to display .



- The interval between shots lengthens when the built-in memory of the camera fills.
- If the flash is used, the interval between shots lengthens because the flash must charge.

Postcard Date Imprint Mode



Shooting Mode



You can shoot images with the optimal settings for postcards by composing them inside the print area (width-to-height ratio of approximately 3:2) shown in the LCD monitor.

1 FUNC. Menu ► **L*** (Recording Pixels) ►

(Post Card Date Imprint).

See *Menus and Settings* (p. 25).

*Default setting.

- The recording pixels are set to **M2** (1600 x 1200) and the compression to (Fine).
- When you press the shutter button halfway, the area that will not get printed at postcard size grays out.

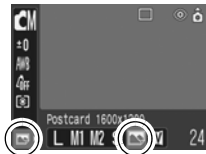

The digital zoom cannot be used in this mode.



For printing instructions, refer to the *Direct Print User Guide*.

Embedding the Date in the Image Data

You can embed the date in image data when (Postcard Date Imprint Mode) is selected.

1 (Rec.) Menu ► [Date Stamp] ► [Date]/[Date & Time].

See *Menus and Settings* (p. 26).

● LCD Monitor Display

: [Off]

: [Date]/[Date & Time]







- Ensure that the camera's date/time is set beforehand (p. 29).
- The date stamp cannot be deleted from the image data once it has been set.

Using the Self-Timer



Shooting Mode



You can set a 10 sec. () or 2 sec. () delay, or a custom delay time and the number of shots () Custom Timer), for shooting after the shutter button is pressed.

1 Press the  button to display ,  or .

2 Shoot.

- When the shutter button is pressed fully, the self-timer will activate and the self-timer lamp will blink. When using red-eye reduction, the self-timer lamp will blink and then stay lit for the last 2 seconds.

To Cancel the Self-Timer

Press the  button to display .





You can change the self-timer sound (p. 96).

Changing the Self-Timer Countdown Time (/)

1  (Rec.) Menu ► [Self-timer] ►  or .

See *Menus and Settings* (p. 26).

- The following occurs with each option.
 - : 2 sec. before the shutter releases, the self-timer lamp and sound will speed up*.
 - : The self-timer sound will play when the shutter button is pressed and the shutter will release 2 sec. later.
- * This may differ depending on your My Camera settings (p. 95).

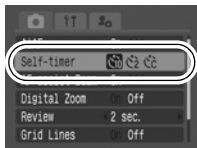

Changing the Delay Time and Number of Shots (📷).

You can change the delay time (0–10, 15, 20, 30 sec.) and number of shots (1–10). These settings, however, cannot be set for the Color Accent, Color Swap, Stitch Assist or movie mode.

1 📷 (Rec.) Menu ▶ [Self-timer] ▶ 📷 ▶ FUNC. SET .

See *Menus and Settings* (p. 26).



2 Change [Delay]/[Shots] ▶ FUNC. SET .

- The self-timer sound will behave as follows.
 - The self-timer sound will start in the last 2 seconds when the delay is set to 2 seconds or more.
 - If multiple shots have been specified for the [Shots] option, the sound will play for the first shot only.



If the [Shots] option is set to 2 or more shots, the following occurs.

- The exposure and white balance are locked at the settings selected for the first shot.
- If the flash is used, the interval between shots lengthens because the flash must charge.
- The interval between shots lengthens when the built-in memory of the camera fills.
- Shooting will automatically cease if the memory card becomes full.



The following movie modes are available.



Standard

You can select the recording pixels and frame rate and record until the memory card is full (when a super high-speed memory card is used, such as the recommended SDC-512MSH). The digital zoom can be used while shooting in this mode. (p. 38)

- Recording Pixels: (640 x 480), (320 x 240)
- Frame Rate: (30 frames/sec.), (15 frames/sec.)
- Maximum Size: 1 GB*/movie



Fast Frame Rate

Use this mode to record fast moving subjects, such as in sports photography.

- Recording Pixels: (320 x 240)
- Frame Rate: (60 frames/sec.)
- Maximum Clip Length: 1 minute



Compact

Since there are few recording pixels and also the data size is small, this mode is convenient for sending movies as e-mail attachments or when the memory card capacity is low.

- Recording Pixels: (160 x 120)
- Frame Rate: (15 frames/sec.)
- Maximum Clip Length: 3 minutes



Color Accent Color Swap

You can shoot and change all colors except a selected one to black and white or shoot and change a selected color to another (pp. 63, 64). As with the Standard mode, you can also select the recording pixels and frame rate and record until the memory card is full (when a super high-speed memory card is used, such as the recommended SDC-512MSH).







- Recording Pixels: (640 x 480), (320 x 240)
- Frame Rate: (30 frames/sec.), (15 frames/sec.)
- Maximum Size: 1 GB*/movie

- The recording time will vary according to the capacity of the memory card you use (p. 123).
- * Recording will stop after one hour of continuous recording even if the recorded data volume has not reached 1 GB.

1 FUNC. Menu * (Standard).

See *Menus and Settings* (p. 25).

*Default setting.

- Use the  or  button to select a movie mode and press the **FUNC./SET** button.
- In ,  or  mode, you can change the recording pixels and frame rate (p. 46).
- See *Changing Colors* (p. 62) for the procedures for using  and .

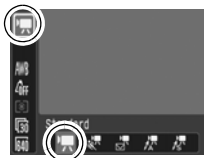

2 Shoot.

- Pressing the shutter button halfway automatically sets the exposure, focus and white balance settings.
- Pressing the shutter button fully starts recording video and sound simultaneously.
- During shooting the recording time and [●Rec] appear on the LCD monitor.
- Pressing the shutter button fully again stops recording. Recording will stop automatically under the following circumstances.
 - When the maximum recording time elapses
 - When the built-in memory or memory card become full





- You are recommended to use a memory card that has been formatted in your camera to shoot movies (p. 32). The card supplied with the camera may be used without further formatting.
- Be careful of the following while recording.
 - Try not to touch the microphone.
 - Do not press any buttons other than the shutter button. The sound that buttons make will be recorded in the movie.
 - The camera will automatically adjust the exposure and white balance to suit the shooting conditions during recording. Please note, however, that the sounds made by the camera automatically adjusting the exposure may also be recorded.
- The focus and optical zoom settings remain fixed for subsequent frames at the values selected for the first frame.



- Before recording, you can set the AE lock (p. 51) and exposure shift.
 1. Press the ISO button.
The exposure will lock (AE lock) and the exposure shift bar will appear in the LCD monitor.
 2. Use the ◀ or ▶ button to adjust the exposure.
Press the ISO button again to release the setting. Also, the setting will be canceled if you press the **MENU** button or change the white balance, My Colors or shooting mode settings.
- QuickTime 3.0 or later is required to play back movies (Data type: AVI/Compression method: Motion JPEG) on a computer. QuickTime (for Windows) is included on the Canon Digital Camera Solution Disk. On the Macintosh platform, this program is standard with Mac OS X or later.



Changing Recording Pixels and Frame Rates

You can change the recording pixels and frame rate when the movie mode is set to  (Standard),  (Color Accent) or  (Color Swap).

1 FUNC. Menu * (Recording Pixels)/ * (Frame Rate).

See *Menus and Settings* (p. 25).













*Default setting.

- Use the  or  button to select recording pixels/frame rate settings and press the **FUNC./SET** button.



Recording Pixels and Frame Rates

Frame rates indicate the number of frames recorded or played back each second. The higher the frame rate, the smoother the appearance of motion.

	Recording Pixels	Frame Rate (frames/sec.)		
				
 Standard	 640 x 480 pixels	–	<input checked="" type="radio"/> * ¹	<input type="radio"/>
 Color Accent	 320 x 240 pixels	–	<input type="radio"/>	<input type="radio"/>
 Color Swap				
 Fast Frame Rate * ²	 320 x 240 pixels	<input type="radio"/>	–	–
 Compact * ²	 160 x 120 pixels	–	–	<input type="radio"/>

*1 Default setting

*2 The recording pixels and frame rate are fixed.



- See *Image Data Sizes (Estimated)* (p. 124).
- See *Memory Cards and Estimated Capacities* (p. 123).

Shooting Panoramic Images (Stitch Assist)



Shooting Mode

Stitch Assist can be used to shoot overlapping images that can later be merged (stitched) to create one panoramic image on a computer.



The overlapping seams of several adjacent images can be joined into a single panoramic image.



1 FUNC. Menu *(Manual) / (Stitch Assist).

See *Menus and Settings* (p. 25).

*Default setting.

- You can select from the following two shooting directions.
 - Left to right horizontally
 - Right to left horizontally



2 Shoot the first image in the sequence.

- The exposure and white balance are set and locked with the first image.

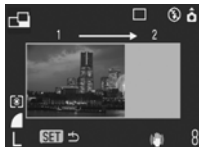

3 **Compose the second image so that it overlaps a portion of the first and shoot.**

- You can retake a shot by pressing the ◀ or ▶ button and returning to the previously recorded image screen.
- Minor discrepancies in the overlapping portions can be corrected when the images are stitched together.

4 **Repeat the procedure for additional images.**

- A sequence may contain up to 26 images.
- Press the **FUNC./SET** button after the last shot.



- You cannot display the images on a TV when shooting in Stitch Assist mode.
- The settings for the first image are applied to the second image onward.



Use PhotoStitch, a supplied software program, to merge the images on a computer.

Shooting Hard-to-Focus Subjects (Focus Lock, AF Lock)

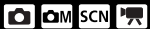

Shooting Mode



It may be difficult to focus on the following types of subjects.





- Subjects with extremely low contrast to the surroundings
- Scenes with a mixture of near and far subjects.
- Subjects with extremely bright objects at the center of the composition
- Subjects that are moving quickly
- Subjects through glass: Try to shoot as close to the glass as possible to reduce the chances of light reflecting back off the glass.



Shooting with the Focus Lock

The focus lock can be used in any shooting mode.

- 1 Aim the camera so that an object at the same focal distance as the main subject is centered in the viewfinder or in the AF frame displayed on the LCD monitor.**
- 2 Press the shutter button halfway.**
- 3 Re-aim the camera to compose the shot as desired and press the shutter button fully.**

Shooting with the AF Lock

The AF lock can be used in the , , ,  or  mode.

- 1 Turn on the LCD monitor.**
- 2 Aim the camera so that an object at the same focal distance as the main subject is centered in the AF frame.**
- 3 Press the shutter button halfway and press the  button.**
 - The  icon will display and the lower indicator will light yellow.

4 Re-aim the camera to compose the shot as desired and shoot.

To Release the AF Lock



Press the  button.



- When shooting with the focus lock or AF lock using the LCD monitor, setting [AiAF] to [Off] (p. 49) makes shooting easier since the camera focuses using the center AF frame only.
- The AF lock is convenient because you can let go of the shutter button to compose the image. Moreover, the AF lock is still effective after the picture is taken, allowing you to capture a second image with the same focus.

Locking the Exposure Setting (AE Lock)



Shooting Mode  

You can set the exposure and focus separately. This is effective when the contrast is too strong between the subject and background or when a subject is backlit.



You must set the flash to . The AE lock cannot be set if the flash fires.

1 Turn on the LCD monitor.

2 Focus on the part of the subject on which you wish to lock the exposure setting.

3 Press the shutter button halfway and press the ISO button.

- The  icon will display.

4 Re-aim the camera to compose the shot as desired and press the shutter button fully.

To Release the AE Lock

Press the ISO button.



- AE lock can also be set and released in mode (p. 45).
- You can use the FE lock when using the flash.

Locking the Flash Exposure Setting (FE Lock)

Shooting Mode

You can lock the flash exposure so that the exposure settings are correctly set regardless of the composition of your subject.

- 1 Turn on the LCD monitor.**
- 2 Press the button and set it to (flash on).**
- 3 Focus on the part of the subject on which you wish to lock the flash exposure setting.**
- 4 Press the shutter button halfway and press the ISO button.**
 - The flash will pre-fire and will display.
- 5 Re-aim the camera to compose the shot as desired and press the shutter button fully.**



To Release the FE Lock

Press the ISO button.

1 FUNC. Menu * (Evaluative).



See *Menus and Settings* (p. 25).

*Default setting.

- Use the  or  button to select the metering mode and press the **FUNC./SET** button.



Metering Methods

	Evaluative	Appropriate for standard shooting conditions, including backlit scenes. The camera divides images into several zones for metering. It evaluates complex lighting conditions, such as the position of the subject, the brightness, the direct light, and the backlighting, and adjusts the settings to the correct exposure for the main subject.
	Center Weighted Average	Averages the light metered from the entire frame, but gives greater weight to the subject matter at the center.
	Spot	Meters the area within the spot AE point at the center of the LCD monitor. Use this setting when you want to set the exposure on the subject in the center of the monitor.

You can set the shutter speed to a slow setting to make dark subjects appear brighter.

1 (Rec.) Menu ► [Long Shutter] ► [On].

See *Menus and Settings* (p. 26).

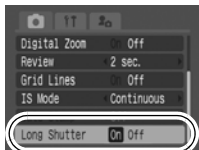

2 FUNC. Menu ► * (Exposure Compensation) ► .

See *Menus and Settings* (p. 25).

*Default setting.



3 Use the or button to select the shutter speed ► .

- The higher the value, the brighter the image and the lower the value, the darker the image.
- If you press the **MENU** button at this point, you will return to the Exposure Compensation setting screen.





The nature of CCD image sensors is such that noise in the recorded image increases at long shutter speeds. This camera, however, applies special processing to images shot at shutter speeds slower than 1.3 seconds to eliminate the noise, thereby producing high-quality images. A certain amount of processing time, however, may be required before the next image can be shot.



- Use the LCD monitor to confirm that the image was recorded at the desired brightness.
- Please note that camera shake becomes a factor at low shutter speeds. Set IS mode to a setting other than [Off] , or shoot with the camera attached to a tripod.
- Use of the flash may result in an over-exposed image. If this occurs, shoot with the flash set to .
- The following are unavailable:
 - Exposure Compensation
 - Metering
 - AE Lock
 - FE Lock
 - ISO speed: Auto, High ISO Auto
 - Flash: Auto, Auto Red-eye Reduction

Adjusting the Tone (White Balance)

Shooting Mode



Normally, the **AWB** (Auto) white balance setting selects an optimal white balance. When the **AWB** setting cannot produce natural looking colors, change the white balance using a setting appropriate for the light source.

1 **FUNC. Menu** **AWB** * (Auto).







See *Menus and Settings* (p. 25).

*Default setting.



- Use the **←** or **→** button to select a white balance setting and press the **FUNC./SET** button.



White Balance Settings

	Auto	Settings are automatically set by the camera
	Day Light	For recording outdoors on a bright day
	Cloudy	For recording under overcast, shady or twilight skies
	Tungsten	For recording under tungsten and bulb-type 3-wavelength fluorescent lighting
	Fluorescent	For recording under warm-white, cool-white or warm-white (3-wavelength) fluorescent lighting
	Fluorescent H	For recording under daylight fluorescent, or daylight fluorescent-type 3-wavelength fluorescent lighting
	Custom	For recording with the optimal white balance data retained in the camera from a white-colored object, such as white paper or cloth



This setting cannot be adjusted when the My Colors mode is set to  or .

Using the Custom White Balance

You can set a custom white balance to obtain the optimal setting for the shooting conditions by having the camera evaluate an object, such as a piece of white paper or cloth, or a photo-quality gray card that you wish to establish as the standard white color.

In particular, take a custom white balance reading for the following situations that are difficult for the **AWB** (Auto) setting to detect correctly.

- Shooting close-ups
- Shooting subjects of monotone color (such as sky, sea or forest)
- Shooting with a peculiar source of light (such as a mercury-vapor lamp)

1 **FUNC. Menu** ► **AWB** * (Auto) ► **Custom**.

See *Menus and Settings* (p. 25).



* Default setting.



2 **Aim the camera at a piece of white paper or cloth and press **(MENU)**.**

- If you are viewing it with the LCD monitor, ensure that the center frame is completely filled with the white image. If you are using the optical viewfinder, ensure that the entire field is filled.



- You are recommended to set the shooting mode to  and the exposure compensation setting to $[\pm 0]$ before setting a custom white balance. The correct white balance may not be obtained when the exposure setting is incorrect (image appears completely black or white).
- Shoot with the same settings as when reading the white balance data. If the settings differ, the optimal white balance may not be set. In particular, the following should not be changed.
 - ISO Speed
 - Flash
Setting the flash to on or off is recommended. If the flash fires when reading the white balance data with the flash set to  (Auto) or  (Auto Red-eye Reduction), make sure that you also use the flash when you shoot.
- Since the white balance data cannot be read in Stitch Assist mode, preset the white balance in another shooting mode beforehand.
- The camera will retain the custom white balance setting that you record even if you reset the camera to the default settings (p. 31).

Shooting in a My Colors Mode











Shooting Mode



You can change the look and feel of the pictures you take.

My Colors Settings

	My Colors Off	Records normally with this setting.
	Vivid	Emphasizes the contrast and color saturation to record bold colors.
	Neutral	Tones down the contrast and color saturation to record neutral hues.
	Sepia	Records in sepia tones.
	B/W	Records in black and white.
	Positive Film	Use this option to make red, green or blue colors more intense like the Vivid Red, Vivid Green or Vivid Blue effects. It can produce intense natural-appearing colors like those obtained with positive film.
	Lighter Skin Tone*	Use this option to make skin tones lighter.
	Darker Skin Tone*	Use this option to make skin tones darker.
	Vivid Blue	Use this option to emphasize blue tints. It makes blue subjects, such as the sky or ocean, more vivid.
	Vivid Green	Use this option to emphasize green tints. It makes green subjects, such as mountains, new growth, flowers and lawns, more vivid.
	Vivid Red	Use this option to emphasize red tints. It makes red subjects, such as flowers or cars, more vivid.
	Custom Color	Use this option to adjust the contrast, sharpness or saturation settings or the color balance between red, green, blue and skin tones*. It can be used to make subtle adjustments, such as making blue colors more vivid or face colors brighter.



* The skin colors of non-human subjects may also be altered.

* You may not obtain the expected results depending on the skin color.

1 FUNC. Menu * (My Colors Off).

See *Menus and Settings* (p. 25).

*Default setting.

● Use the  or  button to select a My Colors mode.

● In 

See *Setting the Camera to a Custom Color Mode* (p. 61).

● When not in 

Press the **FUNC./SET** button to return to the shooting screen.

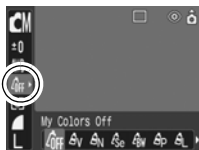

2 Shoot.

Setting the Camera to a Custom Color Mode

This mode allows you to adjust the contrast, sharpness and saturation and the color balance for red, green, blue and skin tones.

1 FUNC. Menu * (My Colors Off) (Custom Color) .

See *Menus and Settings* (p. 25).

*Default setting.



2 Use the or button to select [Contrast], [Sharpness], [Saturation], [Red], [Green], [Blue] or [Skin Tone] and the or button to adjust the setting.

● The altered color will display.

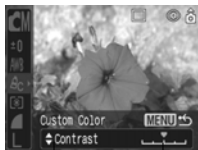

Select a category

Adjust it

3



- This completes the setting.
- If you press the **MENU** button at this point, you will return to the screen where you can select a My Colors mode.

Changing Colors



Shooting Mode

You can shoot images with the original colors transformed. This can be performed on movies as well as still images, allowing you to enjoy photographing with image or movie effects.

However, depending on the shooting conditions, the images may appear rough or you may not get the expected color. Before you try to photograph important subjects, we highly recommend that you shoot trial images and check the results.





If you set [Save Original] (p. 66) to [On] when shooting a still image, you can record the original image as well the transformed one.

	Color Accent	Use this option to have only the color specified in the LCD monitor remain and to transform all others to black and white.
	Color Swap	Use this option to transform a color specified in the LCD monitor into another. The specified color can only be swapped into one other color, multiple colors cannot be chosen.



The ISO speed will rise with some settings, which may increase the "noise" in the image.

Shooting in the Color Accent Mode

- 1 Stills: FUNC. Menu** ▶  * (Portrait) ▶ 
(Color Accent).
- Movies: FUNC. Menu** ▶  * (Standard) ▶ 
(Color Accent).

See *Menus and Settings* (p. 25).

*Default setting.



Stills

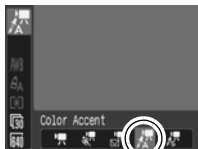

Movies

- 2**  .

• The Color Accent mode will take effect.

- 3**  .

• The camera will switch to color input mode and the display will alternate between the original image and the color accent image (using the previously set color).



- 4 Aim the camera so that the color you wish to retain appears at the center of the LCD monitor and press the ← button.**

- Only one color can be specified.
- You can use the ↑ or ↓ button to specify the range of colors that are retained.
 - -5: Only takes the color that you want to retain
 - +5: Also takes colors close to the one that you want to retain

- 5 Press  to complete the setting, then shoot.**



- The default color accent is green.
- You may not obtain the expected results if you use the flash.
- The specified color accent is retained even if the camera's power is turned off.

Shooting in the Color Swap Mode

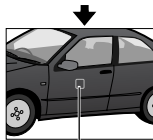

Original Color
(Before Swapping)



Desired Color
(After Swapping)

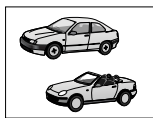

1 Stills: FUNC. Menu ▶ * (Portrait) ▶ (Color Swap).

Movies: FUNC. Menu ▶ * (Standard) ▶ (Color Swap).

See *Menus and Settings* (p. 25).

*Default setting.



Stills

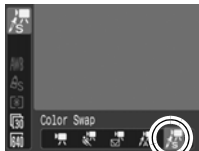

Movies

2

- The Color Swap mode will take effect.

3  .

- The camera will switch to color input mode and the display will alternate between the original image and the color swap image (using the previously set color).

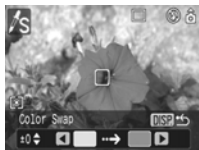
**4** **Aim the camera so that the original color appears at the center of the LCD monitor and press the ← button.**

- Only one color can be specified.
- You can use the ↑ or ↓ button to specify the range of colors that are swapped.
 - -5: Only takes the color that you want to swap
 - +5: Also takes colors close to the one that you want to swap

5 **Aim the camera so that the desired color appears at the center of the LCD monitor and press the → button.**

- Only one color can be specified.

6 Press  to complete the setting, then shoot.

- The default setting for color swap mode changes green into white.
- You may not obtain the expected results if you use the flash.
- The colors specified in the color swap mode are retained even if the camera's power is turned off.

Changing the Save Method for the Original Image

When shooting still images in the Color Accent or Color Swap mode, you can set whether or not to save the original image (pre-transformation) as well as the transformed one.

1 (Rec.) Menu ► [Save Original] ► [On]/[Off].

See *Menus and Settings* (p. 26).

- If [On] is selected, the two images will be numbered consecutively with the altered image following the original.

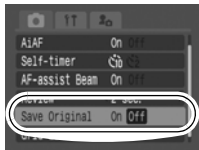















When [Save Original] is Set to [On]

- Only the transformed image displays in the LCD monitor while shooting in the Color Accent or Color Swap mode.
- The transformed image is reviewed in the LCD monitor after shooting in the Color Accent or Color Swap mode. If you erase the image at this point, the original image is erased along with the transformed image. Exercise adequate caution before deleting a file.
- Since two images are recorded with each shot, the number of shots remaining is approximately half the number displayed when this function is set to [Off].

Raise the ISO speed to use a fast shutter speed when you wish to reduce the effects of camera shake or avoid blurry subjects, or to turn the flash off when shooting in a dark area.

1 Press the ISO button and switch settings.

- Cycle through the  /  /  /  /  /  /  speeds with each press of the ISO button.
- Selecting  (Auto) sets the optimal ISO speed according to the light level when shooting. Since the ISO speed setting will automatically be raised in dark places, the camera will select a faster shutter speed and reduce the chances of camera shake.
- Selecting  (High ISO Auto)* sets the sensitivity to a higher value than the  setting. This sets the shutter speed faster, reducing the potential for camera shake or blurry subjects compared with the  setting.
 - * Noise in the recorded image may be higher than for the  setting.
- When in  (Auto) shooting mode, only  or  can be selected.

Setting the Auto Rotate Function



Shooting Mode





Your camera is equipped with an Intelligent Orientation sensor that detects the orientation of an image shot with the camera held vertically and automatically rotates it to the correct orientation when viewing it in the LCD monitor.

1 (Set up) Menu ► [Auto Rotate] ► [On]/[Off].

See *Menus and Settings* (p. 26).

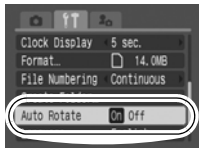
- When shooting and the Auto Rotate function is set to [On] and the LCD monitor is set to the detailed display mode, the  (normal),  (right end is down) or  (left end is down) will appear in the display.



- This function may not operate correctly when the camera is pointed straight up or down. Check that the arrow  is pointing in the right direction and if it is not, then set the Auto Rotate function to [Off].
- Even if the Auto Rotate function is set to [On], the orientation of images downloaded to a computer will depend upon the software used to download the images.



- When the camera is held vertically to shoot, the Intelligent Orientation sensor judges the upper end to be "up" and the lower end to be "down". It then regulates the optimal white balance, exposure and focus for vertical photography. This function operates regardless of the on/off status of the Auto Rotate function.
- You can set the Auto Rotate function separately for the shooting and playback modes.
 - When the Auto Rotate function is set to [On] in shooting mode, the camera's orientation is recorded and the image is automatically switched to the correct orientation in playback mode.
 - When the Auto Rotate function is set to [On] in playback mode, images are rotated to their correct orientation in the LCD monitor according to the camera's orientation.

Creating an Image Destination (Folder)



Shooting Mode



You can create a new folder at any time and the recorded images will be automatically saved to that folder.

Create New Folder	Creates a new folder the next time you shoot images. To create an additional folder, insert another check mark.
Auto Create	You can also specify a date and time if you wish to create a new folder using a shooting time after the specified date and time (p. 29).

Creates a folder the next time you shoot.

1 [F] (Set up) Menu ► [Create Folder].

See *Menus and Settings* (p. 26).

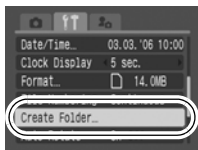

2 Use the ← or → button to add a check mark beside [Create New Folder] ► [MENU].

-  displays in the LCD monitor. The symbol will cease to display after the new folder is created.

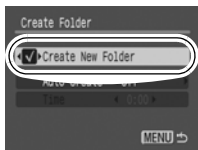

Setting the Day or Time for Automatic Folder Creation

1 [F] (Set up) Menu ► [Create Folder].

See *Menus and Settings* (p. 26).

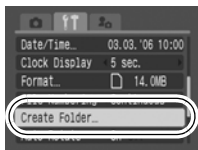

2 Select a day for the [Auto Create] option and a time in the [Time] option ► .

-  displays when the specified time arrives. The symbol will cease to display after the new folder is created.

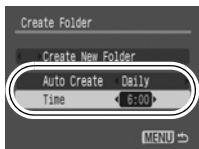

Up to 2000 images can be saved into one folder. A new folder will automatically be created when you record more than that number even if you are not creating new folders.

Resetting the File Number

Shooting Mode



The images you shoot are automatically assigned file numbers. You can select how the file number is assigned.

1 (Set up) Menu ► [File numbering] ► [Continuous]/[Auto reset].

See *Menus and Settings* (p. 26).

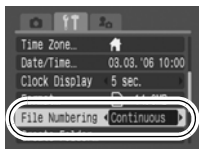

File Number Reset Function

Continuous	A number one higher than the last one recorded is assigned to the next image. This is convenient for managing all your images together on a computer because you avoid file name duplication when changing folders or memory cards.*
Auto reset	The folder and image number are reset to the starting value (100-0001).* This is convenient for managing images on a folder-by-folder basis.

*When a blank memory card is used. If a memory card with recorded data is used, the 7-digit number for the last recorded folder and image is compared with the last one on the card, and the larger of the two is utilized as the basis for new images.

File and Folder Numbers

Recorded images are assigned consecutive file numbers starting with 0001 and ranging up to 9999, while folders are assigned numbers starting with 100 and ranging up to 999. Up to 2,000 images can be saved into a single folder.

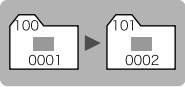
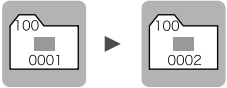
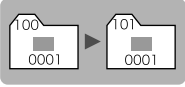
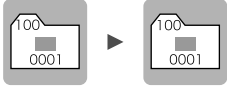
	New Folder Created	Memory Card Exchanged for Another
Continuous	Memory Card 1 	Memory Card 1 Memory Card 2 
Auto Reset	Memory Card 1 	Memory Card 1 Memory Card 2 

- Images may be saved to a new folder when there is insufficient free space even if the total number of images in a folder is less than 2,000 because the following types of image are always saved together into the same folder.
 - Images from continuous shooting
 - Self-timer images (custom)
 - Stitch Assist mode images
 - Still images shot in Color Accent/Color Swap mode with the [Save Original] category set to [On]
- Images cannot be played back when the folder numbers are duplicated or image numbers are duplicated within folders.
- Please refer to the *Software Starter Guide* for information regarding folder structures or image types.

Please also see the *Basic Camera User Guide* (p. 11).

🔍 Magnifying Images

1 Press the zoom lever toward 🔍.

- **SET** 📷 will display and a magnified portion of the image will display.
- Images can be magnified up to a factor of approximately 10x.



Approximate Location of the Displayed Area

2 Use the ←, →, ↑ or ↓ button to move around the image.

- If you press the **FUNC./SET** button while in magnified display, the camera switches to image advance mode and **SET** ⏪ will display. You can use the ← or → button to advance to the next or previous image at the same level of magnification. The image advance mode is canceled when you press the **FUNC./SET** button again.
- You can change the magnification level with the zoom lever.

To Cancel the Magnified Display

Press the zoom lever toward 📷. (You can also cancel it immediately by pressing the **MENU** button.)



Movie frames and index playback images cannot be magnified.

❑ Viewing Images in Sets of Nine (Index Playback)

1 Press the zoom lever toward ❑.

- Up to nine images can be viewed at once.
- Use the ←, →, ↑ or ↓ button to change the image selection.

Selected Image



Movie

Switching between Sets of Nine Images

The jump bar will display if you press the zoom lever toward ❑ while in index playback and you can switch the display between sets of nine images.

- Use the ← or → button to move to the previous or next set of nine images.
- Hold the **FUNC./SET** button down and press the ← or → button to jump to the first or last set.







Jump Bar

To Return to Single Image Playback

Press the zoom lever toward 🔍.

Jumping to Images

When you have many images recorded onto a memory card, it is handy to use the five search keys below to jump over images to find the object of your search.

	Jump 10 Images	Jumps over 10 images at a time.
	Jump 100 Images	Jumps over 100 images at a time.
	Jump Shot Date	Jumps to the first image of each shooting date.
	Jump to Movie	Jumps to a movie.
	Jump to Folder	Displays the first image in each folder.

1 In single image playback mode, press the button.

- The camera will switch to jump search mode.
- The screen sample will vary slightly according to the search key.



Location of image currently being displayed.

Number of images matching search key.

2 Use the **↑** or **↓** button to select a search key and press the **←** or **→** button.

To Return to Single Image Playback

Press the **MENU** button.

Viewing Movies





Movies cannot be played in the index playback mode.

1 Display a movie and

press .

- Images with a  icon are movies.



Movie Control Panel
Volume Level
(Adjust with the  or  button)

2 Select (Play) and press .

- The movie will pause if you press the **FUNC./SET** button during playback. It will resume when you press the button again.
- When playback ends, the movie stops at the last frame displayed. Press the **FUNC./SET** button to display the movie control panel.

Operating the Movie Control Panel



Ends playback and returns to single image playback





Print (An icon will display when a printer is connected. See the *Direct Print User Guide* for details.)



Play



Slow Motion Playback (You can use the  button to slow down or the  button to speed up playback.)



Displays the first frame



Previous Frame (Rewinds if the **FUNC./SET** button is held down)



Next Frame (Fast Forwards if the **FUNC./SET** button is held down)



Displays the last frame



Edit (Switches to movie editing mode) (p. 77)



- Use the television's controls to adjust the volume when playing a movie on a TV set (p. 94).
- The sound cannot be played in slow motion playback.

Editing Movies

You can delete portions of recorded movies.



Protected movies and movies 1 second or less in duration cannot be edited.



- 1 Select  (Edit) in the movie control panel and press .**



- The movie editing panel and the movie editing bar will display.

Movie Editing Panel



Movie Editing Bar

- 2 Use the  or  button to select  (Cut Beginning) or  (Cut End) and the  or  button to specify the cut point(↓).**

- To check a temporarily edited movie, select  (Play) and press the **FUNC./SET** button.
- Selecting  (Exit) cancels the edit and restores the movie control panel.

- 3 Select  (Save) and press .**

4 Select [New File] or [Overwrite] and press



- [New File] saves the edited movie under a new file name. The pre-edit data is left unchanged.

Note, if you press the **FUNC./SET** button while saving the movie, saving is canceled.

- [Overwrite] saves the edited movie with its original name. The pre-edit data is lost.
- When there is not enough space left on the memory card, only [Overwrite] can be selected.



It may take approximately 3 minutes to save an edited movie. If the battery runs out of charge partway through, edited movie clips cannot be saved. When editing movies, it is recommended to use a fully charged battery or the separately sold AC Adapter Kit ACK-DC30 (p. 115).

Rotating Images in the Display

Images can be rotated clockwise 90° or 270° in the display.



Original



90°



270°

1 (Play) Menu .

See *Menus and Settings* (p. 26).

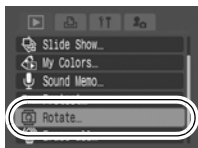

2 Use the or button to select an image to rotate and press to rotate it.



- Cycle through the 90°/270°/original orientations with each press of the **FUNC./SET** button.
- This also can be set in the index playback mode.



- Movies cannot be rotated.
- When images are downloaded to a computer, the orientation of images rotated by the camera will depend upon the software used to download the images.

Playback with Transition Effects

You can select the transition effect displayed when switching between images.

 Off	Standard display.
	The displayed image darkens and the next image gradually brightens until it is displayed.
	Press the ← button to have the previous image display from the left and the → button to have the next image display from the right.

1

 **(Play) Menu**   / .











See Menus and Settings (p. 26).



The transition effect will not display when an image is switched while the camera is reading an image from the memory card.

Adding Effects with the My Colors Function

You can add effects to recorded images (stills only) using the My Colors function. The following selection of My Colors effects is available. For details, see p.60.

 Vivid	 Lighter Skin Tone
 Neutral	 Darker Skin Tone
 Sepia	 Vivid Blue
 B/W	 Vivid Green
 Positive Film	 Vivid Red

1 (Play) Menu .

See Menus and Settings (p. 26).

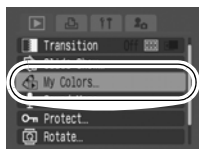

2 Use the or button to select an image and press .



3 Use the or button to select the My Colors type and press .

- The displayed image will reflect the My Colors effect.
- You can press the zoom lever toward  to check the image at a higher magnification. While the image is zoomed, you can press the **FUNC./SET** button to switch between the image transformed with the My Colors effect and the original non-transformed image.





4

Select **[OK]** and press .

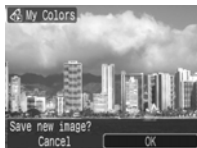
- The newly saved image transformed with the My Colors effect will be the last one in the list.
- To continue adding effects to other images, repeat the procedures from Step 2 onward.



5

Press  and select **[Yes]** or **[No]**, then press .

- Selecting [Yes] displays the image transformed with the My Colors effect, while [No] returns you to the Play menu.



- The My Colors function will not work if there is insufficient space on the memory card.
- Although My Colors effects can be added any number of times to an image, the image quality will gradually deteriorate with each application and the intended colors may not be achieved.
- Color in images taken using My Colors (p. 60) in shooting mode and images edited with the My Colors function in playback mode may differ slightly.

Attaching Sound Memos to Images

In playback mode (including single image playback and index playback), you can attach sound memos (up to one minute) to an image. The sound data is saved in the WAVE format.

1

 **(Play) Menu**  .

See *Menus and Settings* (p. 26).



2 Use the ← or → button to select an image to attach a sound memo to and press .

- The sound memo panel will display.





3 Select (Record) and press .

- The elapsed time and the remaining time display.
- Pressing the **FUNC./SET** button pauses the recording. Pressing it again resumes recording.
- Up to one minute of recordings can be added to any one image.



Sound Memo Panel
Elapsed Time/
Remaining Time
Volume _____
(Adjust with the ↑ or
↓ button)

Sound Memo Panel







	Exit
	Record
	Pause
	Play
	Erase
	Select [Erase] in the confirmation screen and press the FUNC./SET button.

- You cannot attach sound memos to movies.
- Sound memos for protected images cannot be erased.

Automated Playback (Slide Shows)

Automated Playback of Memory Card Images.

*Image settings for slide shows are based on the Digital Print Order Format (DPOF) standard (p. 89).







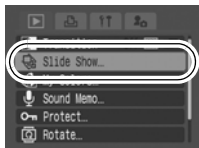

	All Images	Plays all images on a memory card in order.
	Date	Plays images bearing a specified date in order.
	Folder	Plays images in a specified folder in order.
	Movie	Plays movie files only, in order.
	Stills	Plays still images only, in order.
	Custom 1-3	Plays the images selected for each slide show, Custom 1, Custom 2 or Custom 3, in order (p. 86).

1 (Play) Menu .

See *Menus and Settings* (p. 26).



2 **Select** , , , , or .

- For  or , select the image date or folder to be played back (p. 86).
- For ,  or , select the images to be played back (p. 86).
- If you want to add a transition effect to play back images, use the  button to select [Effect] and choose the type of effect with the  or  button (See the next page).

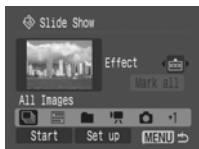





3

Select [Start] and press  .

- The following functions are available during slide shows.
 - Pausing/resuming the slide show: press the **FUNC./SET** button
 - Fast forwarding/rewinding the slide show: press the **◀** or **▶** button (continue to hold the button to switch between images more rapidly)
 - Stopping the slide show: press the **MENU** button.

**Transition Effects**

You can select the transition effect used when one image is replaced by another.

	Standard display.
	The new image gradually brightens as it moves upward from the bottom.
	The new image first appears in a cross shape and gradually expands to display the full image.
	Portions of the new image move horizontally, then the image expands to display the full image.



In single image playback mode (when displaying a still image), you can start a slide show from the current image displayed by holding the **FUNC./SET** button while you press the  button. Please note that if you do this while the last image shot is displayed, the slide show will start from the first image using the same date.

Selecting an Image Date or Folder for Playback (/)

1 Select  or  and press .

2 Use the **←** or **→** button to select the date or folder to be played back and press .

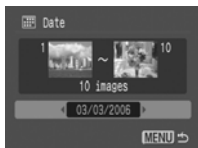



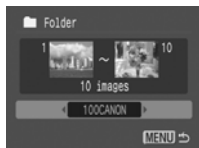

Date









Folder

Selecting Images for Playback (-)

Select only the images that you wish to play back and save them as a slide show (Custom 1, 2 or 3). Up to 998 images can be selected. They will be played back in their order of selection.

1 Select ,  or  and press .

- Only the  icon will display at first. When you set , the icon will change to  and  will display.  and  will change in the same way when they are set.

2 Use the **←** or **→** button to move between images for playback and the  button to select or deselect them.

- You can also select images in the index playback mode.
- Pressing the **MENU** button cancels the setting.

Check mark indicating selection

Number indicating the selection order





Selecting All Images

- 1 After selecting **F1**–**F3** in step 1 (p. 86), use the **▲** button to select [Mark all] and press the **FUNC./SET** button.
 - 2 Use the **▲** button to select [Mark all], press the **FUNC./SET** button.
 - 3 Use the **▶** button to select [OK] and press the **FUNC./SET** button.
- To deselect all images, select [Reset].

Adjusting the Play Time and Repeat Settings

● Play Time

Sets the duration that each image displays. Choose between 3*–10 seconds, 15 seconds and 30 seconds. Displaying time can vary slightly depending on the image.

* Default setting.

● Repeat

Sets whether the slide show stops when all the slides have been displayed or continues until stopped.

1

Select [Set up] and press .

2

Select [Play Time] or [Repeat] and then the desired option.

- Pressing the **MENU** button cancels the setting.

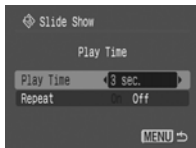

Protecting Images

You can protect important images and movies from accidental erasure.

1 (Play) Menu .

See *Menus and Settings* (p. 26).

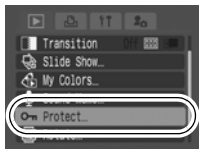

2 Use the or button to select an image to protect and press .

- Pressing the **FUNC./SET** button again cancels the setting.
- You can also protect images in the index playback mode.



Protection Icon

Erasing All Images



- Note that erased images cannot be recovered. Exercise adequate caution before erasing an image.
- Protected images cannot be erased with this function.

1 (Play) Menu .

See *Menus and Settings* (p. 26).



2 Select **[OK]** and press .

- To exit instead of erasing, select **[Cancel]**.



Please format the memory card when you want to erase not only image data but also all the data contained on the card (p. 32).

Setting the DPOF Print Settings

You can select images on a memory card for printing and specify the number of print copies in advance using the camera. The settings used on the camera comply with the Digital Print Order Format (DPOF) standards. This is extremely convenient for printing on a direct print compatible printer, or for sending the images to a photo developing service that supports DPOF.

The  icon may display for a memory card with print settings set by a different DPOF-compliant camera. These settings will be overwritten by those set by your camera.

Single Images



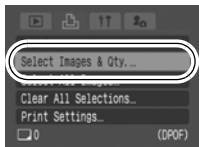

1 Set the mode dial to (playback) (Print) Menu [Select Images & Qty.].

See *Menus and Settings* (p. 26).

- Selecting [Clear All Selections] cancels all print settings for the images.



2 Use the or button to select images for printing.

- Selection methods differ for the Print Type settings (p. 91).
 -  (Standard)/ (Both)Select an image, press the **FUNC./SET** button and use the  or  button to select the number of print copies (up to 99).

Number of Print Copies



-  (Index)

Select an image and the press **FUNC./SET** button to select or deselect it.

- You can also select images in the index playback mode.
- If you are connected to a printer, the  button will light blue while you are selecting images. You can start printing at this point by pressing the  button, confirming that [Print] is selected and pressing the **FUNC./SET** button.



Index Print Selection



All the Images on a Memory Card

1 Set the mode dial to (playback) (Print) Menu [Select All Images].

See *Menus and Settings* (p. 26).

- One copy of every image will be set to print.
- Selecting [Clear All Selections] cancels all print settings for the images.
- If you are connected to a printer, the  button will light blue after the **FUNC./SET** button is pressed. You can start printing at this point by pressing the  button, confirming that [Print] is selected and pressing the **FUNC./SET** button.

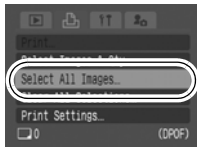

2 Select [OK] and press .

- The output of some printers or photo developing services may not reflect the specified print settings.
- Print settings cannot be set for movies.



- Images are printed in order according to the file number.
- A maximum of 998 images can be selected.
- When [Print Type] is set to [Both], the number of copies can be set. When it is set to [Index], the number of copies cannot be set (only one copy will be printed).

Setting the Print Style

After setting the print style, select the image(s) to print. The following print settings can be selected.

*Default setting

Print Type	<input checked="" type="checkbox"/> Standard*	Prints one image per page.
	<input type="checkbox"/> Index	Prints the selected images together at a reduced size in an index format.
	<input type="checkbox"/> Both	Prints the images in both the standard and index formats.
<input checked="" type="checkbox"/> Date (On/Off*)	Adds the date to the print.	
<input type="checkbox"/> File No. (On/Off*)	Adds the file number to the print.	
Clear DPOF data (On*/Off)	Clears all print settings after the images print.	

1 Set the mode dial to (playback) (Print) Menu [Print Settings].

See *Menus and Settings* (p. 26).

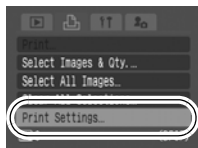

2 Select [Print Type], [Date], [File No.] or [Clear DPOF data] and then specify the settings.



- The Date and File No. settings change according to the Print Type as follows.
 - Index
[Date] and [File No.] cannot be set to [On] at the same time.
 - Standard or Both
[Date] and [File No.] can be set to [On] at the same time, however, the printable information may vary between printers.

- Embedded dates in  (Postcard Date Imprint mode) (p. 40) print out even when [Date] is set to [Off].
- Do not set the date in the DPOF print settings when printing images that have had the date embedded with the [Date Stamp] function. This may cause the date to be printed twice.
- Dates print in the style specified in the [Date/Time] menu (p. 29).

Setting the DPOF Transfer Settings

You can use the camera to specify settings for images before downloading to a computer. Refer to the *Software Starter Guide* for instructions on how to transfer images to your computer.

The settings used on the camera comply with the Digital Print Order Format (DPOF) standards.

The  icon may display for a memory card with transfer settings set by a different DPOF-compliant camera. These settings will be overwritten by those set by your camera.

Single Images

1 (Play) Menu .

See *Menus and Settings* (p. 26).



2 Select [Order] and press .

- Selecting [Reset] cancels all transfer order settings.

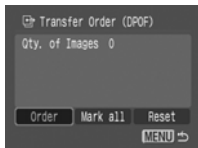

3 Use the ← or → button to select an image to transfer and press .

- Pressing the **FUNC./SET** button again deselects the setting.
- You can also select images in the index playback mode.

Transfer Selection



All the Images on a Memory Card

1 (Play) Menu .

See *Menus and Settings* (p. 26).



2 Select [Mark all] and press .

- Selecting [Reset] cancels all transfer order settings.

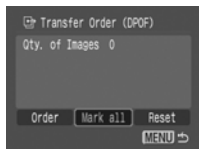

3 Select [OK] and press .



- Images are transferred in order according to the file number.
- A maximum of 998 images can be selected.

Viewing Images on a TV set

You can use a video-compatible television as a monitor to shoot or play back images when it is connected to the camera with the supplied AV Cable.

1 Turn off the Camera and the TV.

2 Connect the AV cable to the camera's A/V OUT terminal.

- Open the DIGITAL terminal cover with a fingernail from the left side and plug the AV cable in all the way.

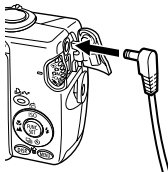

3 Plug the other ends of the AV cable to the VIDEO IN and AUDIO IN jacks on the TV.

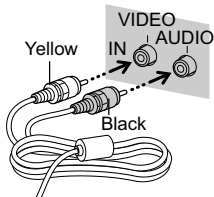

4 Turn on the TV and switch it to video mode.

5 Turn on the camera.



The video output signal can be switched (NTSC or PAL) to accommodate different regional standards (p. 30). The default setting varies between regions.

- NTSC: Japan, U.S.A., Canada, Taiwan and others
- PAL: Europe, Asia (excluding Taiwan), Oceania and others

If the video system is set incorrectly, the camera output may not display properly.

Customizing the Camera (My Camera Settings)

My Camera allows you to customize the start-up image and start-up, operation, self-timer and shutter sounds. You can change and register these settings, enabling you to customize the camera to suit your own tastes.

Changing My Camera Settings

1 (My Camera) Menu ► Menu Item.

See *Menus and Settings* (p. 26).



2 Select the contents you wish to set.

- Select [Theme] to set all to the same settings.

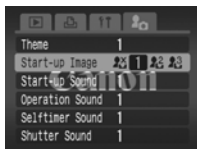

Registering My Camera Settings

Images recorded onto the memory card and newly recorded sounds can be added as My Camera settings to the **[2]** and **[3]** menu items. You can also use the supplied software to upload your computer's images and sounds to the camera.



A computer is required to restore the My Camera settings to the defaults. Use the supplied software (ZoomBrowser EX/ImageBrowser) to restore the default settings to the camera.

1 Set the mode dial to **[▶] (playback)** **[My Camera] Menu** **[Menu Item]** to register.

See *Menus and Settings* (p. 26).

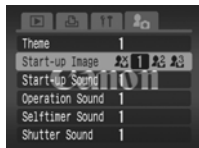

2 Select **[2]** or **[3]** and press **(DISP)**.

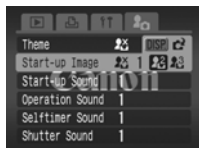



3 Select an image or record a sound.

● Start-up Image



Use the ◀ or ▶ button to select the image you wish to register and press the **FUNC./SET** button.

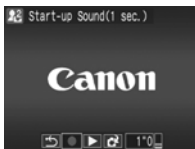

● Start-up, Operation, Self-timer and Shutter Sounds

Select  (Record) and press the **FUNC./SET** button. After recording, select  (Register) and press the **FUNC./SET** button.



- Recording will automatically stop when the recording time elapses.
- To play it, select  (Play).
- To exit instead of registering, press  (Exit).

4 Select [OK] and press .

- To cancel registering, select [Cancel].



- The following cannot be registered as My Camera settings.
 - Movies
 - Sounds recorded with the sound memo function (p. 82)
- The prior setting is erased when a new My Camera setting is added.



See the supplied *Software Starter Guide* for more information on creating and adding to the My Camera data.

Troubleshooting

Camera

Camera will not operate.

Power is not turned on.	● Press the power button (<i>Basic Guide</i> p. 5).
Memory card slot/battery cover is open.	● Confirm that the memory card slot/battery cover is securely closed (<i>Basic Guide</i> p. 2).
Insufficient battery voltage ("Change the battery pack" message displays).	● Insert a fully charged battery into the camera (<i>Basic Guide</i> p. 2). ● Use the AC Adapter Kit ACK-DC30 (sold separately) (p. 115).
Poor contact between camera and battery terminals.	● Polish the terminals with a soft cotton swab before charging or using the battery (p. 111).

Sounds come from the camera interior.

The camera's horizontal/vertical orientation was changed.	● The camera's orientation mechanism is operating. There is no malfunction.
---	---

When the power is turned on

"Card locked!" message appears.

The SD memory card's write protect tab is set to "Write protect".	● When recording to, erasing from or formatting the SD memory card, slide the tab upward (p. 113).
---	--

The Date/Time menu appears.

The built-in rechargeable lithium battery charge is low.	● Recharge the built-in battery immediately (<i>Basic Guide</i> p. 4).
--	---

LCD monitor

The display darkens.

The image in the LCD monitor will darken in strong sunlight or bright light.

- This is a normal occurrence in devices containing CCDs and does not constitute a malfunction. (This image will not be recorded when shooting still images, but it will be recorded when shooting movies.)

Display flickers.

Display flickers when shot under fluorescent lighting.

- This is not a camera malfunction (flickering recorded in movies, but not in still images).

A bar of light (red, purple) appears on the LCD monitor.

Subject is too bright.

- This is a normal occurrence in devices containing CCDs and does not constitute a malfunction. This bar of light will not be recorded when shooting still images, but it will be recorded when shooting movies.



appears.

A slow shutter speed has likely been selected because of insufficient lighting.

- Set IS mode to a setting other than [Off] (p. 35).
- Raise the ISO speed (p. 67) or set the flash to any setting other than  (flash off), or secure the camera to something, such as a tripod (*Basic Guide* p. 9).

▲ appears.

This displays when using a memory card that has print settings, transfer settings or slide show image selections set by other DPOF-compliant cameras.

- Take note that these settings will be overwritten by those set by your camera (pp. 84, 89).

Noise displays./Subject's movements are irregular.



Camera automatically lightened the image displayed on the LCD monitor to make it easier to see when shooting in a dark area (p. 17).

- There is no effect on the recorded image.

Shooting

Camera will not record.

Mode dial is set to  (playback).

- Set the mode dial to , , SCN or  (*Basic Guide* p. 6).

Flash is charging.

- The indicator will light orange when it is charged. You can then shoot (p. 22).

Memory card is full.

- Insert a new memory card (*Basic Guide* p. 2).
- If required, download the images to a computer and erase them from the memory card to make space.

Memory card is not formatted correctly.

- Format the memory card (p. 32).
- If reformatting does not work, the memory card logic circuits may be damaged. Consult the nearest Canon Customer Support Help Desk.

SD memory card is write protected.

- Slide the write protect tab of the SD memory card upward (p. 113).

Image Seen in Viewfinder vs. Recorded Image

Usually the recorded image contains more of the scene than is seen in the viewfinder.

- Confirm the actual image size with the LCD monitor. Use the LCD monitor when taking close-up shots.

Image is blurred or out of focus.

AF-assist Beam is set to [Off].	<ul style="list-style-type: none">● In dark places where it is difficult for the camera to focus, the AF-assist Beam will emit to assist focusing. As the AF-assist Beam will not function when turned off, set it [On] to activate it (p. 27). Take care not to obstruct the AF-assist Beam with your hand when used.
The camera moves when the shutter button is pressed.	<ul style="list-style-type: none">● Set IS mode to a setting other than [Off] (p. 35).● Setting the self-timer to  (2 seconds) delays the shutter release for 2 seconds and allows the camera to stop shaking, thus preventing a blurred image (p. 41). Even better results can be obtained by placing the camera on a stable surface or by using a tripod to shoot.
Subject is out of focal range.	<ul style="list-style-type: none">● Shoot with the subject at the correct shooting distance (p. 119).
The subject is hard to focus on.	<ul style="list-style-type: none">● Use the focus lock or AF lock to shoot (p. 50).

Subject in recorded image is too dark.

Insufficient light for shooting.	<ul style="list-style-type: none">● Set the flash to  (flash on) (<i>Basic Guide</i> p. 9).
The subject is underexposed because the surroundings are too bright.	<ul style="list-style-type: none">● Set the exposure compensation to a positive (+) setting (p. 54).● Use AE lock or use the spot metering function (pp. 51, 53).
Subject is too far away for flash to reach.	<ul style="list-style-type: none">● Shoot within correct shooting distance of the subject when using the built-in flash (p. 120).● Raise the ISO speed and then shoot (p. 67).

Subject in recorded image is too bright, or image flashes white.











Subject is too close, making the flash too strong.	● Shoot within correct shooting distance of the subject when using the built-in flash (p. 120).
The subject is overexposed because the surroundings are too dark.	● Set the exposure compensation to a negative (-) setting (p. 54). ● Use AE lock or use the spot metering function (pp. 51, 53).
Too much light is shining directly into the camera, or is being reflected off the subject.	● Change the shooting angle.
Flash is set to on.	● Set the flash to  (flash off) (<i>Basic Guide</i> p. 9).

Image contains noise.



ISO speed is too high.	● Higher ISO speeds and the  (High ISO Auto) setting may increase image noise. For higher image quality, select as low an ISO speed as possible (p. 67). ● In  ,  ,  ,  ,  ,  ,  and  modes, the ISO speed increases and noise can appear.
------------------------	--

White dots appear on the image.

Light from the flash has reflected off dust particles or insects in the air. This is particularly noticeable when shooting using the wide angle.	● This is a phenomenon that occurs with digital cameras and does not constitute a malfunction.
--	--

Eyes appear red.

Light is reflected back from the eyes when the flash is used in dark areas.

- Use the  (Auto Red-eye Reduction) or  (Red-eye Reduction On) mode (*Basic Guide* p. 9). For this mode to be effective, the subject must be looking right at the red-eye reduction lamp. Try asking them to look directly at the lamp.
- Even better results can be obtained by increasing the lighting in indoor settings or approaching closer to the subject. The shutter will not activate for approximately 1 second after the red-eye reduction lamp fires in order to improve the effect.

Continuous shooting slows down.

The memory card's performance has dropped.

- To enhance the continuous shooting performance, you are recommended to format the memory card in the camera after you save all its images to your computer (p. 32).

Recording images to memory card takes a long time.

Memory card was formatted in another device.

- Use a memory card formatted in your camera (p. 32).

Lens will not retract.

Memory card slot/battery cover was opened with power on.

- First close the memory card slot/battery cover and then turn the power on and then off again. (*Basic Guide* p. 2).

Shooting Movies

The recording time may not display properly or shooting may stop unexpectedly.

The following types of memory cards are used.

- Slow recording cards.
- Cards formatted on a different camera or a computer.
- Cards which have had images recorded and erased repeatedly.

- Although the recording time may not display properly during shooting, the movie will be recorded correctly on the memory card. Recording time will display properly if you format the memory card in this camera (excluding slow recording memory cards) (p. 32).

"!" displayed on the LCD monitor in red and shooting automatically stopped.

There is insufficient free space in the camera's built-in memory.

- Try the following procedures.
 - Format the card with a low level format before shooting (p. 32).
 - Lower the recording pixels or frame rate (p. 46).
 - Use a high-speed memory card (SDC-512MSH, etc.).

Zoom does not operate.

Zoom lever was pressed while shooting in movie mode.

- Operate the zoom before shooting in movie mode (*Basic Guide* p. 9). Note the digital zoom is available while shooting, but only in Standard movie mode (p. 38).

Cannot play back.

You attempted to play back images shot with another camera or images edited with a computer.

- Computer images that cannot be played back will play back if they are added to the camera using the supplied software program ZoomBrowser EX or ImageBrowser. See *ZoomBrowser EX/ImageBrowser Software User Guide* (PDF).

File name was changed with a computer or file location was changed.

- Set the file name or location on the file format/structure of the camera. (Refer to the *Software Starter Guide* for details).

Movies cannot be edited.

Some movies shot with another camera cannot be edited.

Movies do not play back correctly.

Movies recorded with high recording pixels and frame rates may momentarily stop playing if played on slow reading memory cards.

You may experience frame dropping and audio breakup when playing back a movie on a computer with insufficient system resources.

Movies recorded at the  Fast Frame Rate setting and with the video signal set to the PAL format, may play back with a frame rate lower than the recorded one when output to a TV or video. You can play every frame by using the slow motion playback.

- To check the images at the original frame rate, you are recommended to play the movie back on the camera's LCD monitor or on a computer.

Reading images from memory card is slow.

Memory card was formatted in another device.

- Use a memory card formatted in your camera (p. 32).

Battery/Battery Charger

Battery consumed quickly.

Battery life exceeded if battery loses its charge quickly at normal temperature (23 °C/73 °F).

- Replace the battery with a new one (*Basic Guide* p. 2).

Battery will not charge.

Battery life exceeded.

- Replace the battery with a new one (*Basic Guide* p. 2).

TV monitor output

Image not showing on TV monitor.

Incorrect video system setting.

- Set the video system to the appropriate setting, NTSC or PAL, for your TV (p. 30).

Shooting in Stitch Assist mode.

- The output will not appear on a TV in Stitch Assist mode. Cancel the Stitch Assist mode (*Basic Guide* p. 7).

Printing on Direct Print Compatible Printers

Cannot print.

Camera and printer not properly connected.

- Attach the camera to the printer securely with the supplied cable.

Printer power is off.

- Turn on the printer.

Incorrect print connection.

- In the **f1** (Set up) menu, select [Print Method] and select [Auto] (p. 30).

List of Messages

The following messages may appear on the LCD monitor during shooting or playback. Please refer to the *Direct Print User Guide* for the messages that display during a printer connection.

Busy...

- Image is being recorded to, or read from, memory card. The playback mode is starting up.

No memory card

- You turned on the camera without a memory card installed.

Card locked!

- The SD memory card is write-protected.

Cannot record

- You attempted to shoot an image without a memory card installed, or attempted to attach a sound memo to a movie.

Memory card error

- Memory card has experienced an anomaly.

Memory card full

- Memory card is full of images and no more can be recorded or saved. Or no more image settings or sound memos can be recorded.

Naming error!

- The file name could not be created because there is a file with the same name as the folder that the camera is attempting to create, or the highest possible file number has already been reached. In the Set up menu, set the File Numbering option to [Auto Reset]. Save all the images you wish to retain onto a computer, then reformat the memory card. Please note that formatting will erase all the existing images and other data.

Change the battery pack.

- Battery charge is insufficient to operate the camera. Replace it at once with a charged one or recharge the battery.

No image.

- No images recorded on memory card.

Image too large.

- You attempted to play back an image larger than 4992 x 3328 pixels or with a large data size.

Incompatible JPEG format.

- You attempted to play back an incompatible JPEG image.

Corrupted Data.

- You attempted to play back an image with corrupted data.

RAW

- You attempted to play back a RAW image.

Unidentified Image

- You attempted to play back an image that was recorded in a special data type (proprietary data type used by the camera of another manufacturer, etc.) or a movie clip recorded by another camera.

Cannot magnify!

- You attempted to magnify an image recorded in a different camera or data type, an image edited with a computer, or a movie.

Cannot rotate

- You attempted to rotate an image recorded in a different camera or data type, an image edited with a computer, or a movie.

Incompatible WAVE format.

- A sound memo cannot be added to this image since the data type of the existing sound memo is incorrect.

Cannot register this image!

- You attempted to register an image recorded in a different camera or a movie as a start-up image.

Cannot modify image

- You attempted to apply a My Colors effect to a movie or an image recorded in a different camera.

Cannot transfer!

- When transferring images to your computer using the Direct Transfer menu, you attempted to select an image with corrupted data or an image taken with a different camera or data type. You may have also attempted to select a movie when [Wallpaper] was selected in the Direct Transfer menu.

Protected!

- You attempted to erase or edit a protected image, movie or sound memo.

Too many marks.

- Too many images have been marked with print settings, transfer settings or slide show settings. Cannot process any more.

Cannot complete!

- Could not save the print, transfer or slide show settings.

Unselectable image.

- You attempted to set the print settings for a non-JPEG image.

Communication error

- The computer was unable to download the image due to the large amount of images (approx. 1000) stored on the memory card.

Lens error, restart camera

- Camera detected an error while moving the lens and cut the power automatically. This error message may appear if you press on the lens while it is moving or turn on the camera in a dusty or sandy environment. Turn on the camera again and shoot or playback images. Take the camera to a service center if this message appears frequently because there may be a problem with the lens.

Exx

- (xx: number) Camera detected an error. Turn the power off and then back on, then shoot or play back. A problem exists if the error code reappears. Note the number and contact your Canon Customer Support Help Desk. If an error code displays directly after taking a picture, the shot may not have been recorded. Check image in playback mode.

Battery Handling

Battery Charge

The following icon and message will display.



Battery charge is low.
Recharge it as soon as possible it will be used for an extended period.

Change the battery pack

Battery charge is insufficient to operate the camera. Replace the battery immediately.

Battery Handling Precautions

- **Keep the battery terminals clean at all times.**
Dirty terminals may cause poor contact between the battery and camera. Polish the terminals with a soft cotton swab before charging or using the battery.
- **At low temperatures, battery performance may be reduced and the low battery icon (🔋) may appear earlier than usual.**
Under these conditions, revive the battery by warming it in a pocket immediately before use.
- **However, ensure that there are no metallic items in the pocket that could cause a short circuit, such as a key ring, etc.**
The battery may be short circuiting.
- **Do not allow any metal objects such as key rings to touch the (⊕) and (⊖) terminals (Fig. A). To carry the battery or store it during periods of disuse, always replace the terminal cover (Fig. B).**
These conditions can damage the battery.

Fig. A



Fig. B

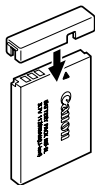

You may be able to check the charge state depending upon how the terminal cover is attached (Fig. C, D).

Fig. C



Charged Battery
Attach it so the ▲
is visible

Fig. D

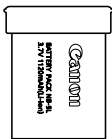

Spent Battery
Attach it the
opposite way to
Fig. C.

- You are recommended to use it in the camera until it is completely discharged and to store it in an indoor location with low relative humidity and between the temperatures of 0 – 30 °C (32 – 86 °F).

Storing a fully charged battery for long periods of time (about one year) may shorten its life cycle or affect its performance. If you do not use the battery for long periods of time, charge it fully and discharge it fully in the camera about once a year before returning it to storage.

Charging the Battery

- Since this is a lithium-ion battery, you need not completely discharge it before recharging.
- It takes approximately 2 hours 5 minutes to fully charge the battery from a fully discharged state (based on Canon's testing standards).
 - Charging it within a temperature range of 5 – 40 °C (41 – 104 °F) is recommended.
 - Charge times may vary according to the ambient temperature and the battery's charge state.
- You are advised to charge the battery on the day of use, or one day before, to ensure a full charge.
Even charged batteries continue to discharge naturally.
- If the performance of the battery diminishes substantially even when it is fully charged, its life has been exceeded and it should be replaced.

Handling the Memory Card

SD Memory Card Write Protect Tab

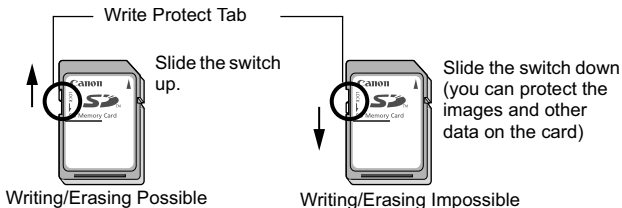

Cautions When Handling

- Memory cards are high-precision electronic devices. Do not bend them, apply force to them, or subject them to shocks or vibration.
- Do not attempt to disassemble or alter the memory card.
- Do not allow dirt, water or foreign objects to contact the terminals on the back of the card. Do not touch the terminals with your hands or metal objects.
- Do not peel away the original label on the memory card or cover it with another label or sticker.
- When writing on the memory card, do not use a pencil or ball-point pen. Only use a soft point pen (e.g. felt-tip pen).
- Do not use or store memory cards in the following locations.
 - Locations subject to dust or sand
 - Locations subject to high humidity and high temperatures
- Since some or all of the data recorded on the memory card may be corrupted or erased by electrical noise, static electricity, or camera or card malfunction, making a backup copy of important data is recommended.

Formatting

- **Please note that formatting (initializing) an memory card erases all data, including protected images.**
- **You are recommended to use memory cards that have been formatted in your camera.**
 - The card supplied with the camera may be used without further formatting.
 - When the camera is malfunctioning, a corrupted memory card might be the cause. Reformatting the memory card may solve the problem.
 - When a non-Canon brand memory card is malfunctioning, reformatting it may solve the problem.
 - Memory cards formatted in other cameras, computers, or peripheral devices may not operate correctly in this camera. When that happens, reformat the memory card with this camera.
- **If formatting in the camera does not work properly, turn the camera off and re-insert the memory card. Then turn the camera back on and format again.**

Using an AC Adapter Kit (Sold Separately)

It is best to power the camera with AC Adapter Kit ACK-DC30 (sold separately) when you are using it for long periods of time or connecting it to a computer.



Turn the camera power off before connecting or disconnecting the AC adapter.

- 1 Connect the power cord to the compact power adapter first and then plug the other end into the power outlet.**

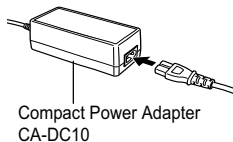

- 2 Open the memory card slot/battery cover, then insert the DC coupler until it is locked.**

- Slide the memory card slot/battery cover closed.

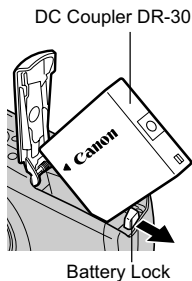

- 3 Open the DC coupler terminal cover and attach the cord to the DC terminal.**

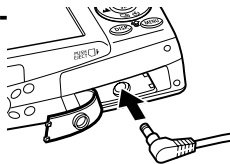

Using an Externally Mounted Flash (Sold Separately)

High-Power Flash HF-DC1

This flash is used to supplement the camera's built-in flash when the subject is too far away for proper illumination. Use the following procedures to affix the camera and High-Power Flash to the supporting bracket.

Please read the instructions accompanying the flash along with this explanation.

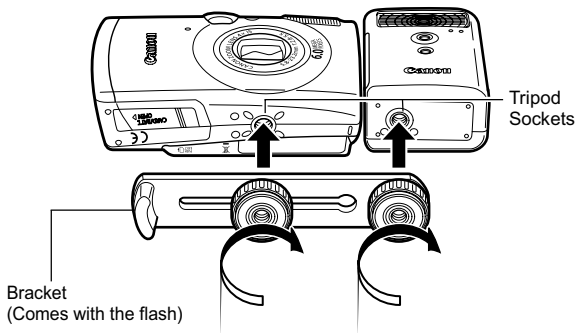

- The flash charge time will lengthen as the battery charge gets weaker. Always set the power/mode switch to [OFF] when you finish using the flash.
- Be careful not to touch the flash window or sensor windows with your fingers while the flash is in use.
- The flash may fire if another flash is being used in close proximity.
- The High-Power Flash may not fire outdoors in daylight or when there are no reflective items.
- For continuous shooting, although the flash fires for the first shot, it does not fire for subsequent shots.
- Fasten the attachment screws securely so that they do not loosen. Failure to do so may lead to the dropping of the camera and flash resulting in damage to both.



- Before attaching the bracket to the flash, check that the lithium battery (CR123A or DL123) is installed.
- To illuminate the subjects properly, install the flash so that it is up against the side of the camera and parallel with the camera's front panel.
- A tripod can be used even when the flash is attached.

Batteries

● Charge becomes Severely Limited

If the battery usage time has considerably diminished, wipe the battery terminals well with a dry cloth. The terminals may be dirty from fingerprints.

● Usage in Cold Temperatures (Less than 0°C/32°F)

Get a spare generic lithium battery (CR123A or DL123). You are recommended to place the spare battery in your pocket to warm it up before switching it for the battery in the flash.

● Non-Use over Extended Periods

Leaving batteries in the High-Power Flash could allow the battery fluid to leak, damaging the product. Remove the batteries from the High-Power Flash and store them in a cool, dry place.

Camera Care and Maintenance

Never use thinners, benzine, synthetic cleansers or water to clean the camera. These substances may distort or damage the equipment.

Camera Body

Gently wipe dirt off the camera body with a soft cloth or eyeglass lens wiper.

Lens

First use a lens blower brush to remove dust and dirt, then remove any remaining dirt by wiping the lens lightly with a soft cloth.



Never use synthetic cleansers on the camera body or lens. If dirt remains, contact the closest Canon Customer Support Help Desk as listed on the customer support list supplied with your camera.

Viewfinder and LCD Monitor

Use a lens blower brush to remove dust and dirt. If necessary, gently wipe with a soft cloth or an eyeglass lens wiper to remove stubborn dirt.



Never rub or press strongly on the LCD monitor. These actions may damage it or lead to other problems.

Specifications

All data is based on Canon's standard testing methods. Subject to change without notice.

PowerShot SD700 IS DIGITAL ELPH/DIGITAL IXUS 800 IS

(W): Max. wide angle (T): Max. telephoto

Camera Effective Pixels	Approx. 6.0 million
Image Sensor	1/2.5-inch CCD (Total number of pixels: Approx. 6.2 million)
Lens	5.8 (W) – 23.2 (T) mm (35mm film equivalent: 35 (W) – 140 (T) mm) f/2.8 (W) – f/5.5 (T)
Digital Zoom	Approx. 4.0x (Up to approx. 16x in combination with the optical zoom)
Optical Viewfinder	Real-image zoom viewfinder
LCD Monitor	2.5-inch, low-temperature polycrystalline silicon TFT color LCD, approx. 173,000 pixels (Picture coverage 100%)
AF System	TTL autofocus Focusing frame: 9-point AiAF/1-point AF (fixed to center)
Shooting Distance (From the front of the lens)	Normal: 45 cm (1.5 ft.) – infinity Macro: 2 – 60 cm (W)/40 – 60 cm (T) (0.79 in. – 2.0 ft. (W)/1.3 – 2.0 ft. (T)) Infinity: 3 m (9.8 ft.) – infinity
Shutter	Mechanical shutter + electronic shutter
Shutter Speeds	15 – 1/1600 sec. The shutter speed varies according to the shooting mode. Slow shutter speeds of 1.3 sec. or slower operate with noise reduction.
Metering System	Evaluative, Center-weighted average or Spot (fixed to center)
Exposure Compensation	± 2 stops in 1/3-stop increments
ISO Speed	Auto*, High ISO Auto*, ISO 80/100/200/400/800 equivalent * Camera automatically sets the optimal speed.

White Balance	Auto, Day Light, Cloudy, Tungsten, Fluorescent or Fluorescent H or Custom
Built-in Flash	Auto, auto with red-eye reduction, flash on with red-eye reduction, flash on, flash off, slow synchro
Flash Range	Normal: 50 cm – 3.5 m (1.6 – 11.5 ft.) (W), 50 cm – 2.0 m (1.6 – 6.6 ft.) (T) (When ISO speed is set to AUTO.)
Shooting Modes (Still images)	Auto, Manual ¹ , Digital macro ² , Stitch assist ² , Special Scene ³ , 1 Long shutter mode available 2 Selectable in Manual mode. 3 Portrait, Night Snapshot, Kids&Pets, Indoor, Foliage, Snow, Beach, Fireworks, Underwater, Color Accent, Color Swap
(Movies)	Standard, Fast Frame Rate, Compact, Color Accent, Color Swap
Continuous Shooting	Approx. 2.1 shots/sec. (Large/Fine mode)
Self-timer	Activates shutter after an approx. 10-sec./ approx. 2-sec. delay, Custom Timer
Recording Media	SD memory card/MultiMediaCard This camera has been tested with memory cards through 2GB. Use of all memory cards cannot be guaranteed.
File Format	Design rule for camera file system and DPOF compliant
Data Type (Still images)	Exif 2.2 (JPEG)* ¹
(Movies)	Sound memos: WAVE (Monaural) AVI (Image data: Motion JPEG; Audio data: WAVE (Monaural))
Compression	Superfine, Fine, Normal
Number of Recording Pixels (Still Images)	Large: 2816 x 2112 pixels Medium 1: 2272 x 1704 pixels Medium 2: 1600 x 1200 pixels Small: 640 x 480 pixels Postcard Date Imprint Mode: 1600 x 1200 pixels Widescreen: 2816 x 1584 pixels

Number of Recording Pixels (Movies)	<p>Standard, Color Accent, Color Swap: 640 x 480 pixels (30 frames/sec., 15 frames/sec.) 320 x 240 pixels (30 frames/sec., 15 frames/sec.)</p> <p>Recording can continue until the memory card is full* (can record up to a maximum of 1 GB** at one time).</p> <p>Fast Frame Rate: (can record for 1 min.) 320 x 240 pixels (60 frames/sec.)</p> <p>Compact: (can record for 3 min.) 160 x 120 pixels (15 frames/sec.)</p> <p>* Using super high-speed memory cards (SDC-512MSH recommended).</p> <p>**Even if the clip size has not reached 1 GB, recording will stop at the moment the clip length reaches 1 hour. Depending on the volume and data writing speed of the memory card, recording may stop before reaching 1 hour or before the recorded data volume has reached 1 GB.</p>
Playback Modes	<p>Single (histogram displayable), Index (9 thumbnail images), Magnified (approx. 10x (max.) in LCD monitor, advance or reverse through magnified images possible), Jump (jumps to every tenth or hundredth image, to the first image of those sharing a certain shooting date, to movies, or to the first image in a folder. In index playback mode, it displays 9 images at once.), Sound memos (up to 1 min.), Slide show, My Colors or Movie (edit/slow motion play back possible).</p>
Direct Print	<p><i>PictBridge</i> compliant, and <i>Canon Direct Print</i> and <i>Bubble Jet Direct</i> compatible</p>
My Camera Settings	<p>Start-up image, start-up sound, operation sound, self-timer sound, and shutter sound.</p>
Interface	<p>USB 2.0 Hi-Speed (mini-B), PTP (Picture Transfer Protocol)</p> <p>Audio/Video output (NTSC or PAL selectable, monaural audio)</p>
Power Source	<p>Battery Pack NB-5L (Lithium-ion Rechargeable battery)</p> <p>AC Adapter Kit ACK-DC30</p>
Operating Temperatures	<p>0 – 40 °C (32 – 104 °F)</p>

Operating Humidity	10 – 90%
Dimensions	90.4 x 56.5 x 26.4 mm (3.56 x 2.22 x 1.04 in.)
Weight (camera body only)	Approx. 165 g (5.82 oz.)

*1 This digital camera supports Exif 2.2 (also called “Exif Print”). Exif Print is a standard for enhancing the communication between digital cameras and printers. By connecting to an Exif Print-compliant printer, the camera’s image data at the time of shooting is used and optimized, yielding extremely high quality prints.

Battery Capacity (Battery Pack NB-5L (Fully charged))

Number of Images Shot		Playback Time
LCD Monitor ON (Based on the CIPA standard)	LCD Monitor Off	
Approx. 240 images	Approx. 700 images	Approx. 6 hours

- The actual figures will vary according to the shooting conditions and settings.
- Movie data is excluded.
- At low temperatures, the battery performance may diminish and the low battery icon may appear very rapidly. In these circumstances, the performance can be improved by warming the battery in a pocket before use.

Test Conditions

Shooting: Normal temperature (23 °C ± 2 °C/73 °F ± 3.6 °F), normal relative humidity (50% ± 20%), alternating wide angle end and telephoto end shots at 30 second intervals with the flash fired once every two shots and the camera power turned off after every tenth shot. Power is left off for a sufficient amount of time*, then the power is turned back on and the testing procedure is repeated.

- A Canon-brand memory card is used.

*Until the battery returns to normal temperature

















Playback: Normal temperature (23 °C ± 2 °C/73 °F ± 3.6 °F), normal relative humidity (50% ± 20%), continuous playback at 3 seconds per image.



See *Battery Handling Precautions* (p. 111).









Memory Cards and Estimated Capacities







: Card included with the camera

Recording Pixels	Compression	16MB	SDC-128M	SDC-512MSH
L (Large) 2816 x 2112 pixels		4	45	176*
		8	75	292
		17	156	603
M1 (Medium 1) 2272 x 1704 pixels		6	61	237
		12	109	425
		24	217	839
M2 (Medium 2) 1600 x 1200 pixels		13	121	471
		24	217*	839
		46	411	1590
S (Small) 640 x 480 pixels		52	460	1777
		80	711	2747
		127	1118	4317
 (PostCard Date Imprint Mode) 1600 x 1200 pixels		24	217*	839
W (Widescreen) 2816 x 1584 pixels		6	60	235
		11	101	392
		23	205	794

-  Capable of smooth continuous shooting (p. 39) (*Only available when card has been formatted with a low level format).
- This reflects standard shooting criteria established by Canon. Actual results may vary according to the subject and shooting conditions.









Movie















	Recording Pixels	Frame Rate	16MB	SDC-128M	SDC-512MSH
 Standard	 640 x 480 pixels		6 sec.	1 min. 4 sec.	4 min. 9 sec.
			14 sec.	2 min. 7 sec.	8 min. 14 sec.
 Color Accent	 320 x 240 pixels		20 sec.	3 min. 1 sec.	11 min. 42 sec.
 Color Swap			40 sec.	5 min. 55 sec.	22 min. 53 sec.

 Fast Frame Rate	 320 x 240 pixels		10 sec.	1 min. 32 sec.	5 min. 59 sec.
 Compact	 160x 120 pixels		1 min. 39 sec.	14 min. 29 sec.	55 min. 57 sec.

* Maximum movie clip length at : 1 min., at : 3 min. The figures indicate the maximum continuous recording time.

Image Data Sizes (Estimated)

Recording Pixels	Compression		
			
 (2816 x 2112 pixels)	2720 KB	1620 KB	780 KB
 (2272 x 1704 pixels)	2002 KB	1116 KB	556 KB
 (1600 x 1200 pixels)	1002 KB	558 KB	278 KB
 (640 x 480 pixels)	249 KB	150 KB	84 KB
 (1600 x 1200 pixels)	–	558 KB	–
 (2816 x 1584 pixels)	2026 KB	1210 KB	585 KB

	Recording Pixels	Frame Rate	File size
 Standard	 (640 x 480 pixels)		1920 KB/sec.
			960 KB/sec.
 Color Accent	 (320 x 240 pixels)		660 KB/sec.
			330 KB/sec.
 Color Swap			
 Fast Frame Rate	 (320 x 240 pixels)		1320 KB/sec.
 Compact	 (160 x 120 pixels)		120 KB/sec.

SD Memory Card

Interface	Compatible with SD memory card standards
Dimensions	32.0 x 24.0 x 2.1 mm (1.3 x 0.9 x 0.1 in.)
Weight	Approx. 2 g (0.07 oz.)

MultiMediaCard

Interface	Compatible with MultiMediaCard standards
Dimensions	32.0 x 24.0 x 1.4 mm (1.3 x 0.9 x 0.06 in.)
Weight	Approx. 1.5 g (0.05 oz.)

Battery Pack NB-5L

Type	Lithium-ion Rechargeable battery
Nominal Voltage	3.7 V DC
Typical Capacity	1120 mAh
Cycle Life	Approx. 300 times
Operating Temperatures	0 – 40 °C (32 – 104 °F)
Dimensions	32.0 x 44.9 x 7.9 mm (1.26 x 1.77 x 0.31 in.)
Weight	Approx. 25 g (0.88 oz.)

Battery Charger CB-2LX/CB-2LXE

Rated Input	100 – 240 V AC (50/60 Hz) 8.5 VA (100 V) – 12 VA (240 V) (CB-2LX) 0.085 A (100 V) – 0.05 A (240 V) (CB-2LXE)
Rated Output	4.2 V DC, 0.7 A
Charging Time	Approx. 2 hour 5 minutes
Operating Temperatures	0 – 40 °C (32 – 104 °F)
Dimensions	57.5 x 81.6 x 21.0 mm (2.26 x 3.21 x 0.83 in.)
Weight	Approx. 65 g (2.29oz.) (CB-2LX) Approx. 59 g (2.08 oz.) (CB-2LXE) (excluding power cord)

Compact Power Adapter CA-DC10

(Included with the separately sold AC Adapter Kit ACK-DC30)

Rated Input	100 – 240 V AC (50/ 60 Hz) 16 VA (100 V) – 26 VA (240 V)
Rated Output	4.3 V DC, 1.5 A
Operating Temperatures	0 – 40 °C (32 – 104 °F)
Dimensions	42.6 x 104.4 x 31.4 mm (1.7 x 4.1 x 1.2 in.)
Weight (excluding power cord)	Approx. 180 g (6.3 oz.)

INDEX

A

- AC Adapter Kit ACK-DC30... 115
- AE Lock 51
- AF Frame 18, 49
- AF Lock 50
- AF-assist Beam 27
- AiAF 49
- Auto Play (Slide Show)..... 84
- Auto Rotate Function..... 68
- AV Cable 94

B

- Battery
 - Battery Capacity 122
 - Charging 112, Basic 1
 - Handling 111
 - Installing Basic 2

C

- Clock Display 16
- Compression 33
- Continuous Shooting 39
- Create Folder 69
- Custom White Balance 58

D

- Date/Time
 - Setting Basic 4
 - Using the Clock 16
 - World Clock 23
- Digital Macro 37
- DIGITAL Terminal .. 13, Basic 19
- Digital Zoom 38
- Direct Transfer..... Basic 22
- Downloading Images to a Computer..... Basic 16
- DPOF Print Order
 - Print Style 91
 - Selecting Images 89
- DPOF Transfer Order..... 92

E

- Erasing
 - All Images 88
 - Single Images 14, Basic 11
- Exposure..... 54
- Exposure Shift 45

F

- FE Lock..... 52
- File Number 70
- Flash 14, Basic 9
- Focus 49
- Focus Lock 50
- Frame Rate..... 46
- FUNC. Menu 25
- FUNC./SET button 14

G

- Grid Line 27

H

- HF-DC1..... 116
- Histogram 21

I

- Image Data Sizes (Estimated) 124
- Index Playback 74
- Indicator 22
- Infinity 14, Basic 10
- Interface Cable Basic 14, 18
- IS Mode 35
- ISO Speed 67

J

- JUMP (Image Search) 75

L

Language	Basic 4
LCD Monitor	
Information Displayed	18
Night Display	17
Playback Information	19
Quick-bright LCD	17
Shooting Information	18
Using the LCD Monitor	15

M

Macro	14, Basic 10
Magnifying	73
Memory Card	
Estimated Capacities	123
Formatting	32, 114
Handling	113
Inserting	Basic 2
Menu	
FUNC. Menu	25, 27
Menu List	27
Menus and Settings	25
My Camera Menu	30
Play Menu	28
Print Menu	28
Rec. Menu	27
Set up Menu	28
MENU button	14
Messages	108
Metering Modes	53
Mode Dial	14, Basic 5, 6
Movie	
Editing	77
Playback	76
Shooting	43
Mute	28, Basic 5
My Camera Menu	30
My Camera Settings	95
My Colors (Playback)	81
My Colors (Shooting)	60

P

Playback	Basic 11
Postcard Date Imprint Mode	40
Power Button	14, Basic 5
Power Saving	22, 29
Print/Share Button	14, Basic 14, 22
Printing	Basic 14
Protect	88

R

Recording Pixels	33, 46
Red-Eye Reduction ..	12, Basic 9
Reset All	31
Rotate	79

S

Self-Timer	41
Set up Menu	28
Shooting Mode	
Auto	Basic 7
Digital Macro	37
Manual.....	36, Basic 7
Digital Macro	Basic 7
Stitch Assist.....	Basic 7
Movie.....	43, Basic 8
Selecting.....	Basic 6
Special Scene.....	36, Basic 7
Beach	Basic 8
Color Accent.....	63, Basic 8
Color Swap.....	64, Basic 8
Fireworks.....	Basic 8
Foliage.....	Basic 7
Indoor	Basic 7
Kids&Pets.....	Basic 7
Night Snapshot.....	Basic 7
Portrait.....	Basic 7
Snow	Basic 7
Underwater.....	Basic 8
Stitch Assist.....	47
Shutter Button.....	14
Fully.....	Basic 6
Halfway.....	Basic 5
Shutter Speed.....	55
Slide Show.....	84
Repeat Settings.....	87
Selecting.....	86
Transition Effects.....	85
Smooth Continuous Shooting.	39
Sound Memo	82
Spot AE Point Frame.....	53
Spot Frame.....	18
System Requirements ..	Basic 17

T

Telephoto.....	Basic 9
Time Zone	23, 29
Transition Effects	
Playback.....	80
Slide Show	85

V

Video System.....	94
-------------------	----

W

White Balance.....	57
Wide Angle.....	Basic 9
Wrist Strap	12

Z

Zoom.....	Basic 9
-----------	---------

MEMO

MEMO

MEMO

MEMO

Disclaimer

- While every effort has been made to ensure that the information contained in this guide is accurate and complete, no liability can be accepted for any errors or omissions.
- Canon reserves the right to change the specifications of the hardware and software described herein at anytime without prior notice.
- No part of this guide may be reproduced, transmitted, transcribed, stored in a retrieval system, or translated into any language in any form, by any means, without the prior written permission of Canon.
- Canon makes no warranties for damages resulting from corrupted or lost data due to a mistaken operation or malfunction of the camera, the software, SD memory cards (SD cards), personal computers, peripheral devices, or use of non-Canon SD cards.

Trademark Acknowledgments

- Macintosh, Mac OS and QuickTime are trademarks of Apple Computer Inc., registered in the United States and/or other countries.
- Microsoft[®] and Windows[®] are either registered trademarks or trademarks of Microsoft Corporation in the United States and/or other countries.
- SD is a trademark.
- Other names and products not mentioned above may be registered trademarks or trademarks of their respective companies.

This product is not intended to be serviced. Should the product cease to function in its intended manner, it should be returned to the manufacturer or be discarded.

This power unit is intended to be correctly orientated in a vertical or floor mount position.

IMPORTANT SAFETY INSTRUCTIONS-SAVE THESE INSTRUCTIONS.

DANGER-TO REDUCE THE RISK OF FIRE OR ELECTRIC SHOCK, CAREFULLY FOLLOW THESE INSTRUCTIONS.

For connection to a supply not in the U.S.A., use an attachment plug adapter of the proper configuration for the power outlet.

This battery charger is for exclusive use with Battery Pack NB-5L (1.12 Ah). There is a danger of explosion if other battery packs are used.

Copyright © 2006 Canon Inc. All rights reserved.

FCC Notice

(Digital Camera, Model PC1176)

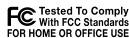

This device complies with Part 15 of the FCC Rules. Operation is subject to the following two conditions;

- (1) this device may not cause harmful interference, and
- (2) this device must accept any interference received, including interference that may cause undesired operation.

Note: This equipment has been tested and found to comply with the limits for Class B digital devices, pursuant to Part 15 of the FCC rules. These limits are designed to provide reasonable protection against harmful interference in a residential installation. This equipment generates, uses and can radiate radio frequency energy and, if not installed and used in accordance with the instructions, may cause harmful interference to radio communications. However, there is no guarantee that interference will not occur in a particular installation. If this equipment does cause harmful interference to radio or television reception, which can be determined by turning the equipment off and on, the user is encouraged to try to correct the interference by one or more of the following measures:

- Reorient or relocate the receiving antenna.
- Increase the separation between the equipment and receiver.
- Connect the equipment into an outlet on a circuit different from that to which the receiver is connected.
- Consult the dealer or an experienced radio/TV technician for help.

The cable with the ferrite core provided with the digital camera must be used with this equipment in order to comply with Class B limits in Subpart B of Part 15 of the FCC rules.

Do not make any changes or modifications to the equipment unless otherwise specified in the manual. If such changes or modifications should be made, you could be required to stop operation of the equipment.

Canon U.S.A. Inc.,

One Canon Plaza, Lake Success, NY 11042, U.S.A.

Tel No. (516) 328-5600

Canadian Radio Interference Regulations

This Class B digital apparatus complies with Canadian ICES-003.

Réglementation canadienne sur les interférences radio

Cet appareil numérique de la classe B est conforme à la norme NMB-003 du Canada.

Functions Available in Each Shooting Mode

The chart below is a reference for the settings available for various shooting conditions. The settings selected in each shooting mode are saved after you finish shooting.

Function												Page
Recording Pixels	Large		●	●	●	▲	●	●	–	p.33		
	Medium 1		○	○	○	△	○	○	–			
	Medium 2		○	○	○	△	○	○	–			
	Small		○	○	○	△	○	○	–			
	Postcard		○	○	–	–	○	○	–			
	Widescreen		○	○	–	–	○	○	–			
	Movie		–	–	–	–	–	–	○ ⁽¹⁾		p.46	
Compression	Super Fine		○	○	○	△	○	○	–	p.33		
	Fine		●	●	●	▲	●	●	–			
	Normal		○	○	○	△	○	○	–			
Frame Rate			–	–	–	–	–	–	○ ⁽²⁾	p.46		
Flash ⁽³⁾	Auto		○	○	–	–	○	○	–	Basic p.9		
	Red-eye Reduction		●	●	–	–	○	○	–			
	Red-eye Reduction On		–	–	–	–	○	–	–			
	On		–	○	–	△	○	○	–			
	Off		○	○	●	▲	○	●	–			
	Slow Synchro		–	○	–	△	–	○	–			
Macro Mode			○	○	–	△	○ ⁽⁴⁾	○	○	Basic p.10		
Infinity Mode			–	○	–	△	○ ⁽⁴⁾	○	○	p.50		
AF Lock			–	○	○	–	–	–	○ ⁽⁵⁾	p.51		
AE Lock			–	○	○	–	–	–	○	p.52		
FE Lock			–	○	–	–	–	–	–			
Shooting Method	Single		●	●	●	●	●	●	●	–		
	Continuous Shooting		–	○	○	–	○	–	–	p.39		
	10-sec. Self-Timer		○	○	○	○	○	○	○	p.41		
	2-sec. Self-Timer		○	○	○	○	○	○	○			
	Custom Timer		○	○	○	–	○	–	–			
Autofocus Modes			–	○	○	–	○ ⁽⁶⁾	○	–	p.49		
AF-assist Beam			○	○	○	△	○ ⁽⁷⁾	○	○	p.27		
Digital Zoom			○	○	○ ⁽⁸⁾	–	○	–	● ⁽⁹⁾	p.38		

Function						SCN			Page
Metering Method	Evaluative	— ⁽¹⁰⁾	●	●	●	— ⁽¹⁰⁾	— ⁽¹⁰⁾	— ⁽¹⁰⁾	p.53
	Center-Weighted Average	—	○	○	—	—	—	—	
	Spot	—	○	○	—	—	—	—	
Exposure Compensation		—	○	○	△	○	—	—	p.54
Exposure Shift		—	—	—	—	—	—	○	p.45
Long Shutter		—	○	—	—	—	—	—	p.55
White Balance		—	○	○	△	— ⁽¹⁰⁾	— ⁽¹⁰⁾	○ ⁽⁵⁾	p.57
My Colors		—	○	○	△	—	—	○ ⁽⁵⁾	p.60
ISO Speed		○ ⁽¹¹⁾	○	○	—	— ⁽¹⁰⁾	— ⁽¹⁰⁾	—	p.67
Auto Rotate		○	○	○	△	○	○	—	p.68
Grid Lines		○	○	○	—	○	○	○	p.27
IS Mode		○	○	○	○	○	○	○ ⁽¹²⁾	p.35

○ Setting available (● Default setting)

△ Setting can only be selected for the first image. (▲ Default setting)

■ (Shaded Area): Setting is retained even when the camera power is shut off.

With the exception of the [Time Zone], [Date/Time], [Language] and [Video System] settings, all the other menu settings and changes made with the camera buttons can be reset to the default values in a single operation (p. 31).

(1)(2) The recording pixels and frame rates for the (Movie) mode are as follows.

	Recording Pixels			Frame Rate		
	●	○	—	—	●	○
	—	●	—	●	—	—
	—	—	●	—	—	●

(3) The default flash setting is Auto Red-eye Reduction in the modes, Auto in the modes, and Off in the modes.

- The flash cannot be set in mode.

- When the flash fires in mode, the camera will automatically use Slow Synchro mode.

(4) You cannot switch between the Macro/Infinity modes when the camera is in the modes.

(5) Cannot be selected in the or mode.

(6) AF cannot be selected in the modes.

(7) The AF-assist Beam cannot be set in mode.

(8) [Off] cannot be selected in the mode.

(9) Can only be set and used in the mode.

(10) Automatically set by the camera.

(11) can be selected.

(12) The [Continuous] and [Panning] options cannot be selected in mode.